

EN SKID PLATE INSTALLATION MANUAL

DE MONTAGEEINLEITUNG FÜR UNTERBODENSCHUTZSYSTEM

RU ИНСТРУКЦИЯ ПО УСТАНОВКЕ КОМПЛЕКТА ЗАЩИТ



For: BRP Can-Am Outlander L 450, 500 (2015-)

K.7278.1

2K.7278.1



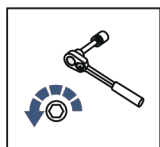

EN Regular fasteners
DE Originale montageteile
RU Штатный крепеж

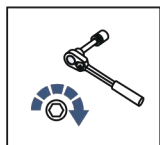

EN Regular fasteners
DE Originale montageteile
RU Штатный крепеж



EN Screw a several turns
DE Für wenigen Umdrehungen befestigen
RU Вкрутить на несколько оборотов

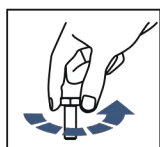

EN Loosen bolts
DE Bolzen lockern
RU Выкрутить на несколько оборотов

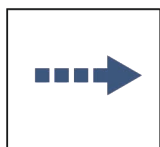

EN Movement Arrow
DE Bewegungsrichtung
RU Движение

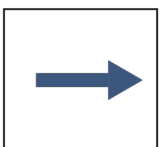

EN Location/Position Arrow
DE Anordnung/Positionsrichtung
RU Расположение



EN Screw Arrow
DE Drehungsrichtung
RU Поворот

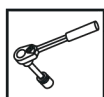

EN Ratchet
DE Ratsche
RU Трещётка

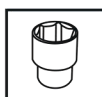



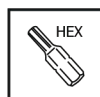



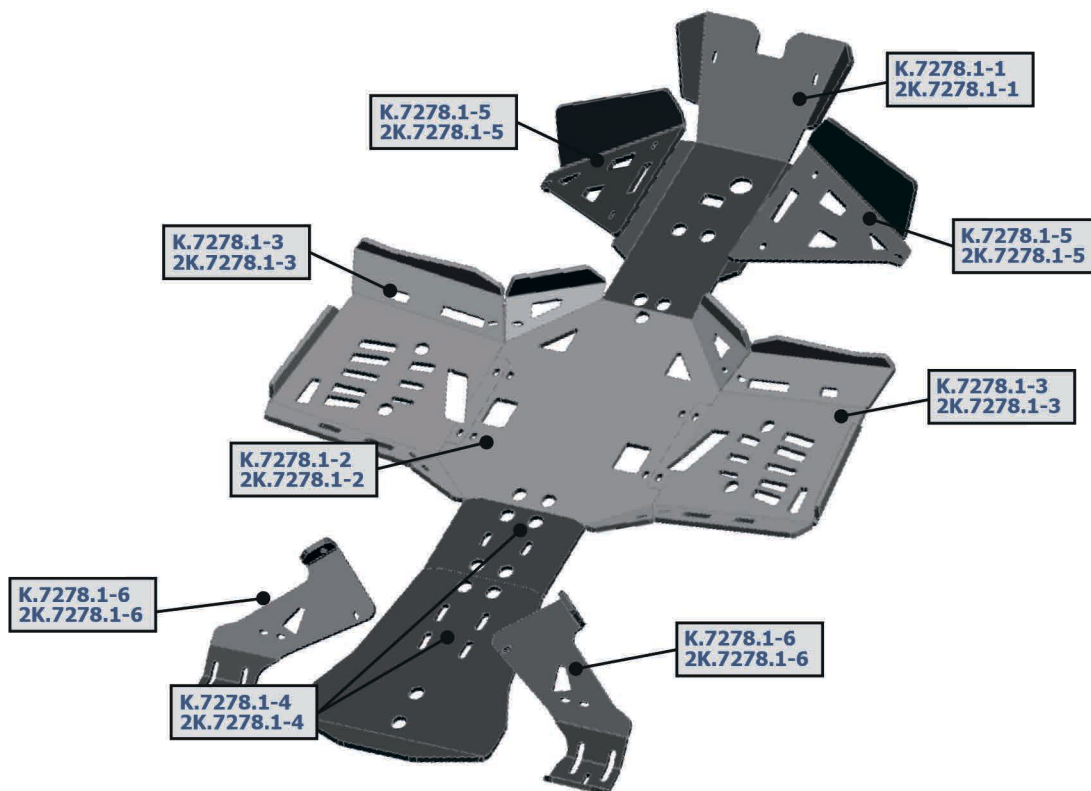

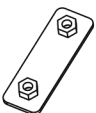

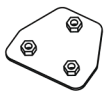



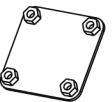
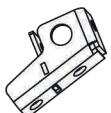

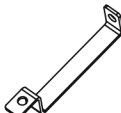
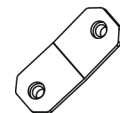
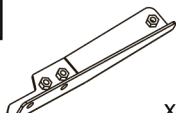
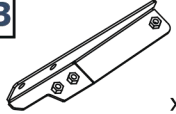









S - 10;
S - 13



HEX
S - 4;
S - 5



1  x1	2  M8 x10	3  x1	4  x1	5  x1	6  M8 x2
7  x1	8  x1	9  x1	10  x2	11  x4	12  x2
13  x2	14  M8x35 x11	15  M8x25 x8	16  M8x20 x8	17  M8x30 x22	18  M8x40 x2
19  M8x35 x2	20  M8x45 x2	21  M6x35 x4	22  M6x60 x2	23  M8 x19	24  Ø8 x28
25  Ø8 x10	26  Ø6 x6	27  Ø6 x4	28  M8 x2	29  M6 x6	30  x4
31  x2					

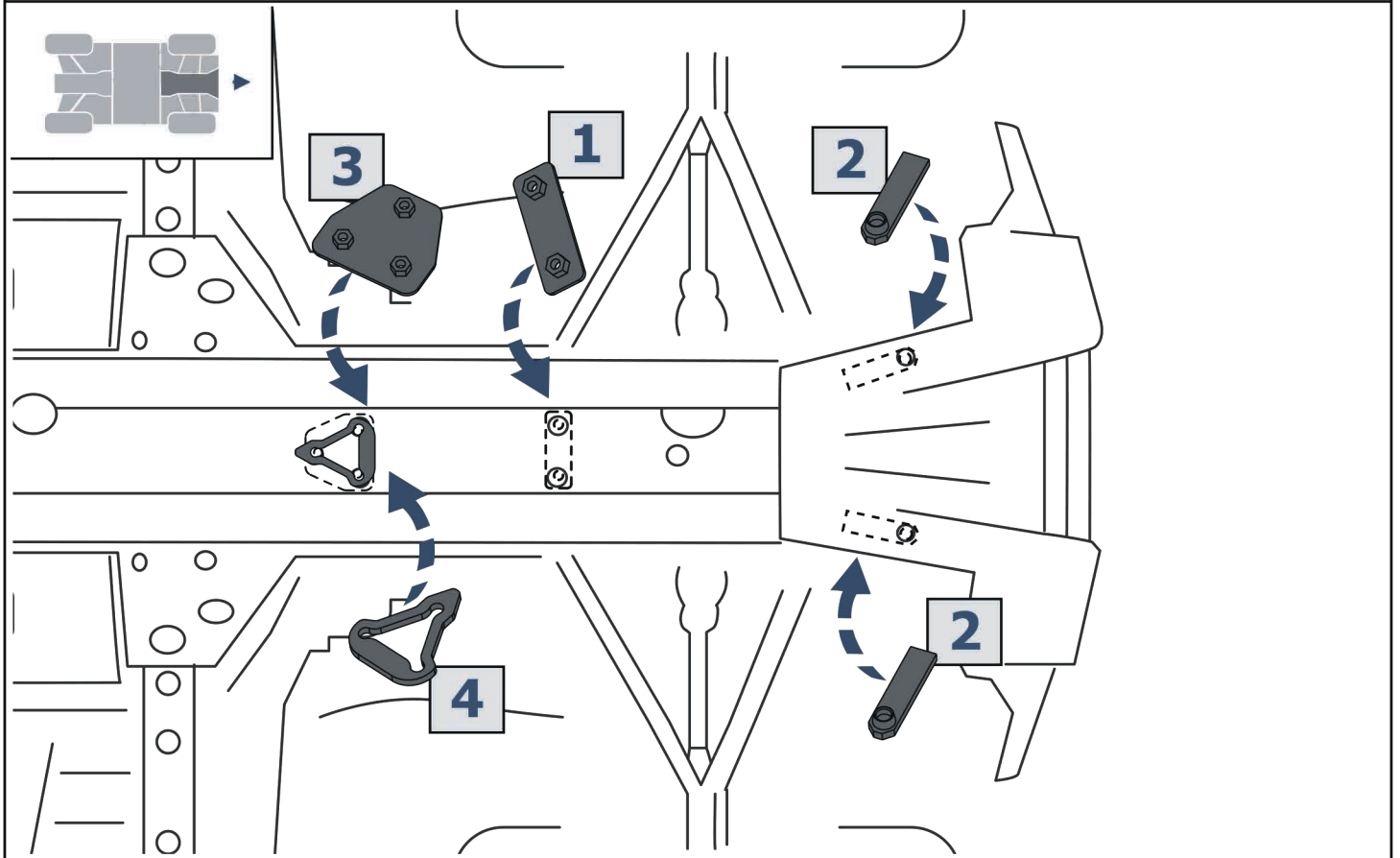
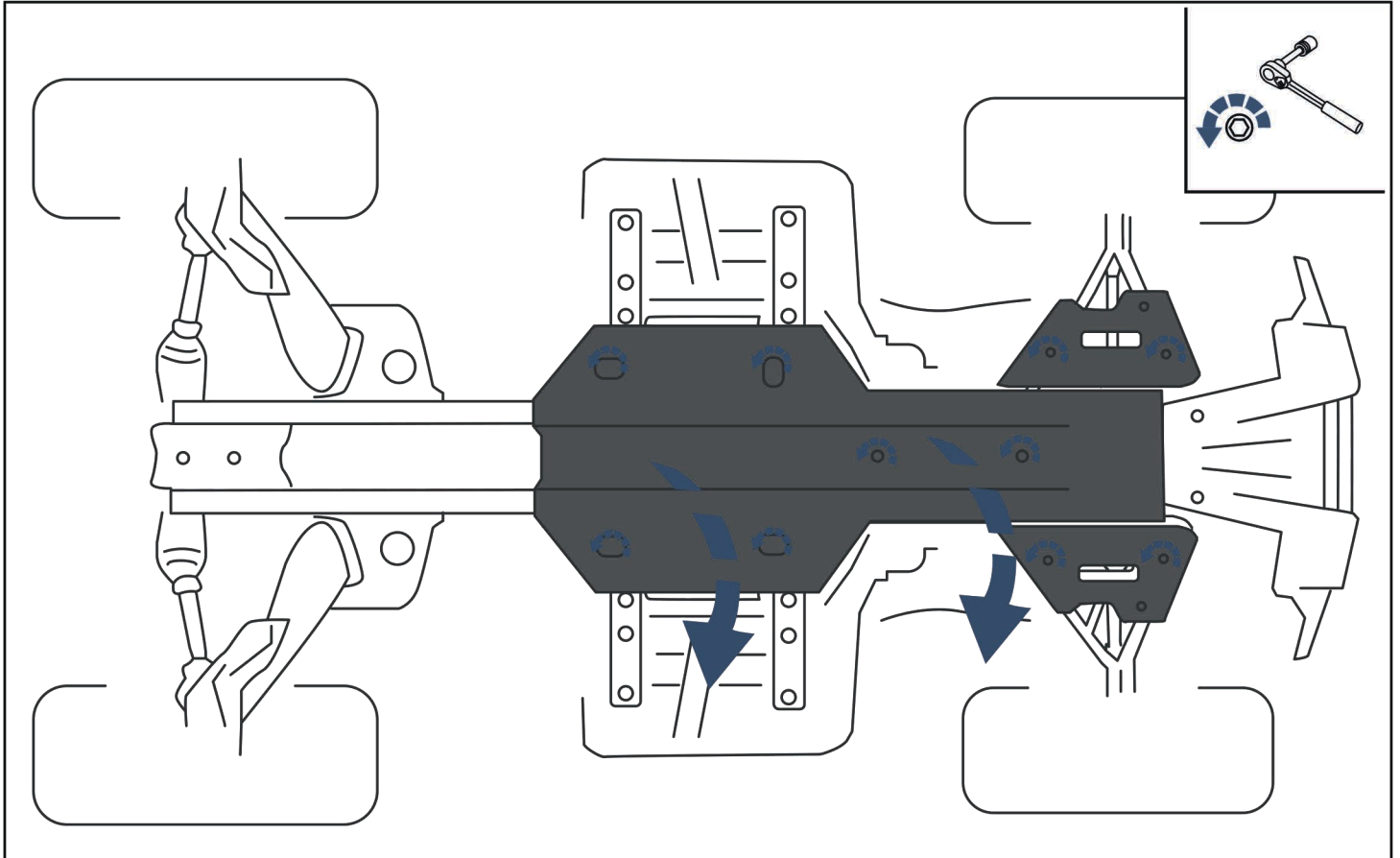

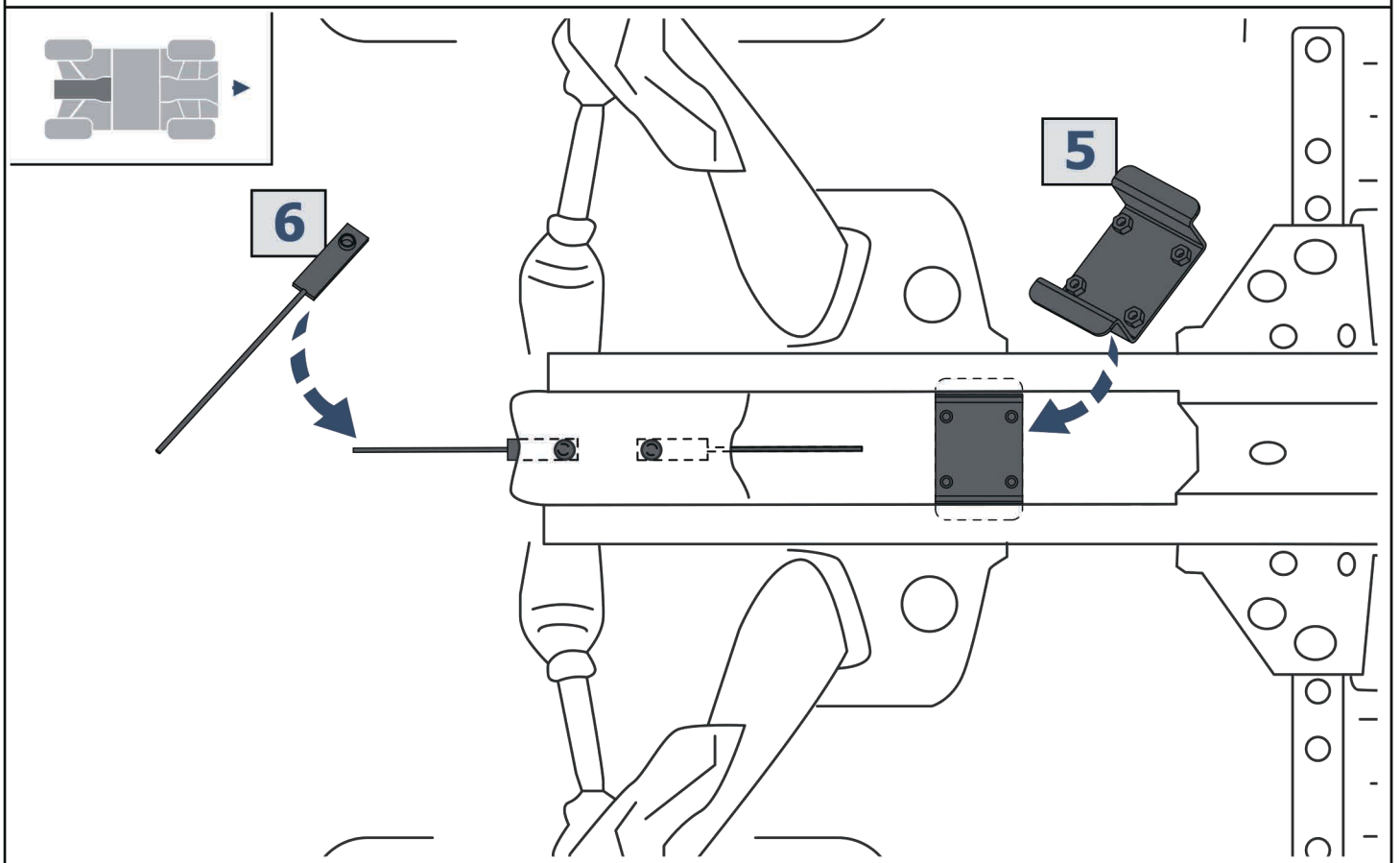
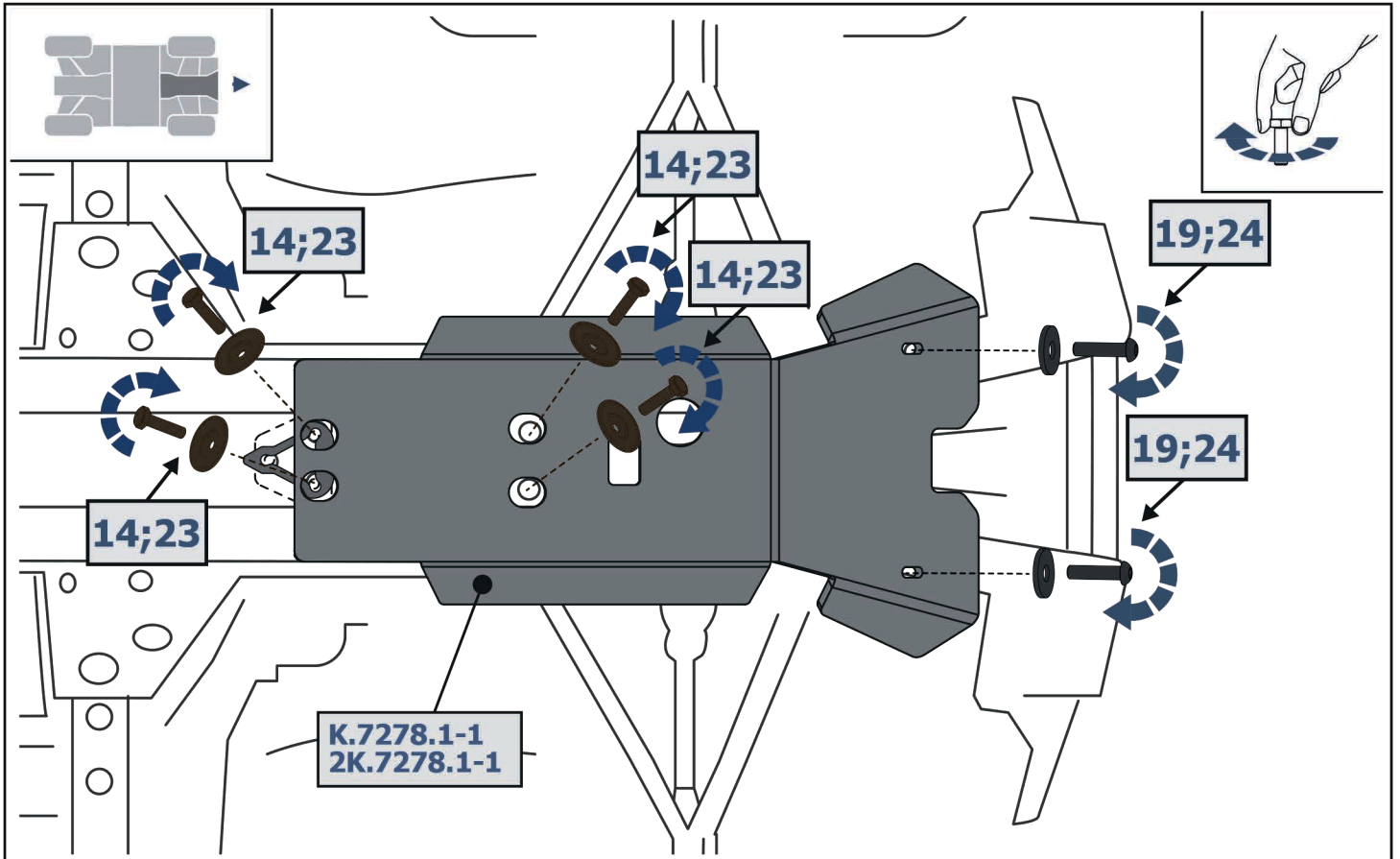

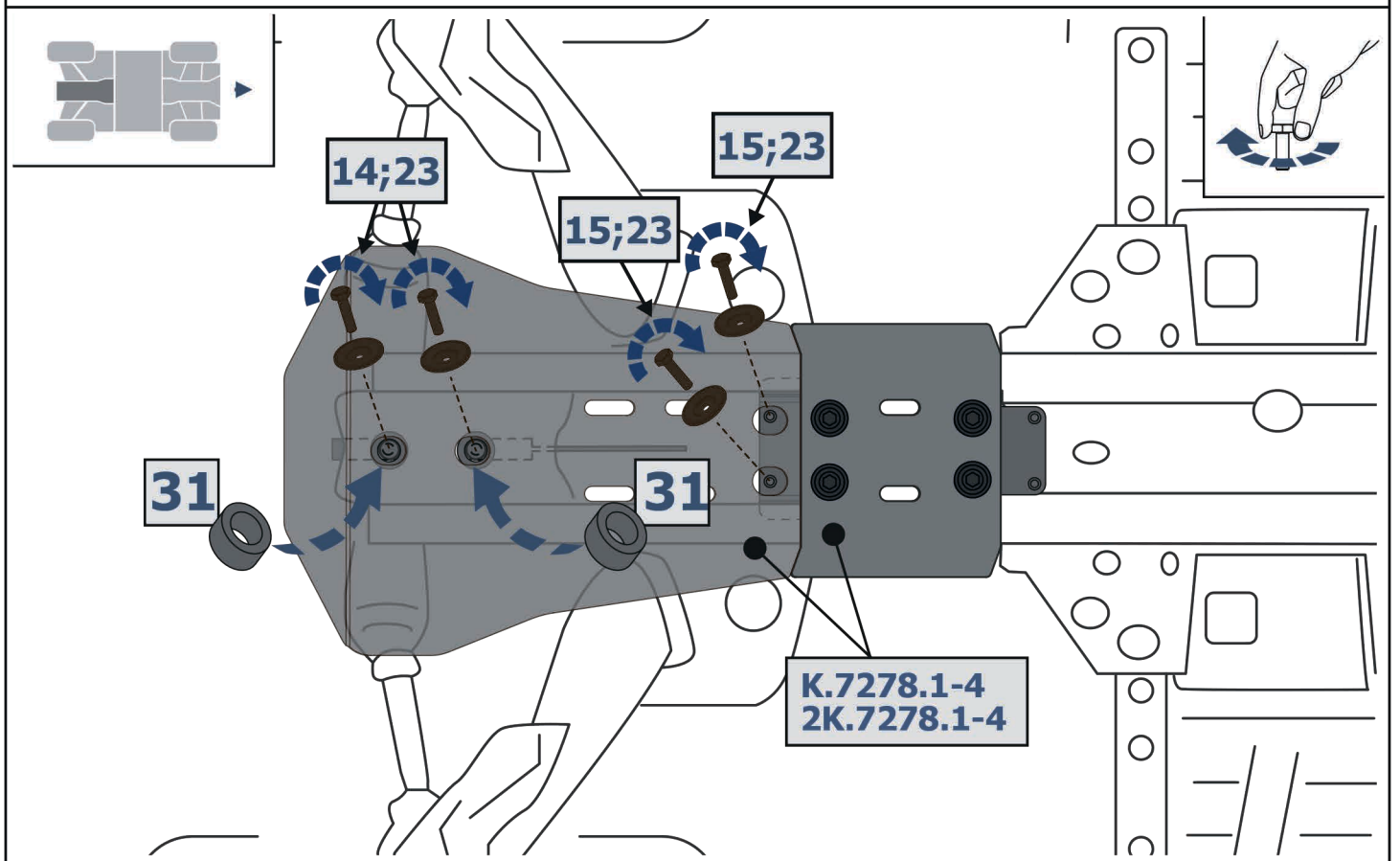
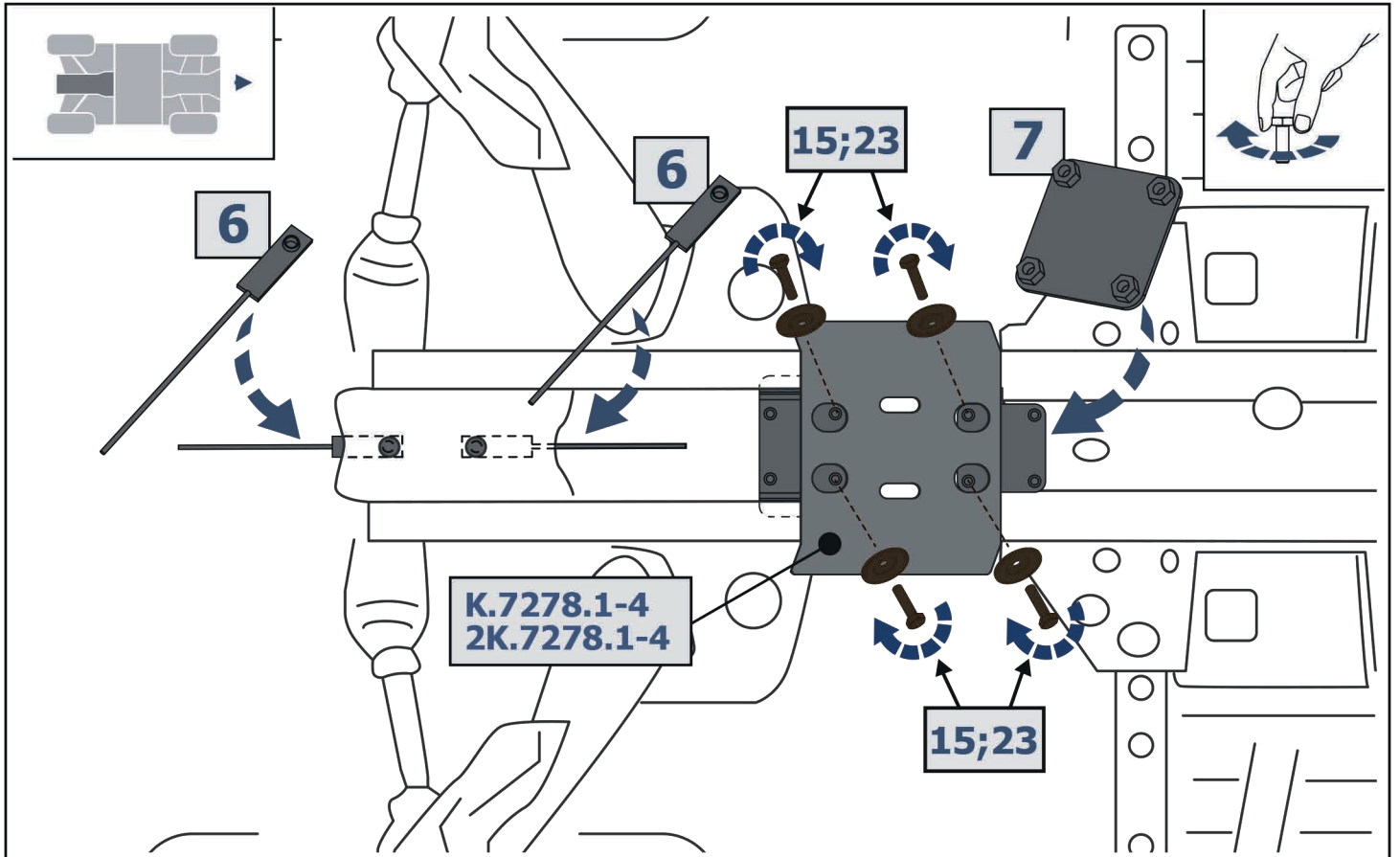

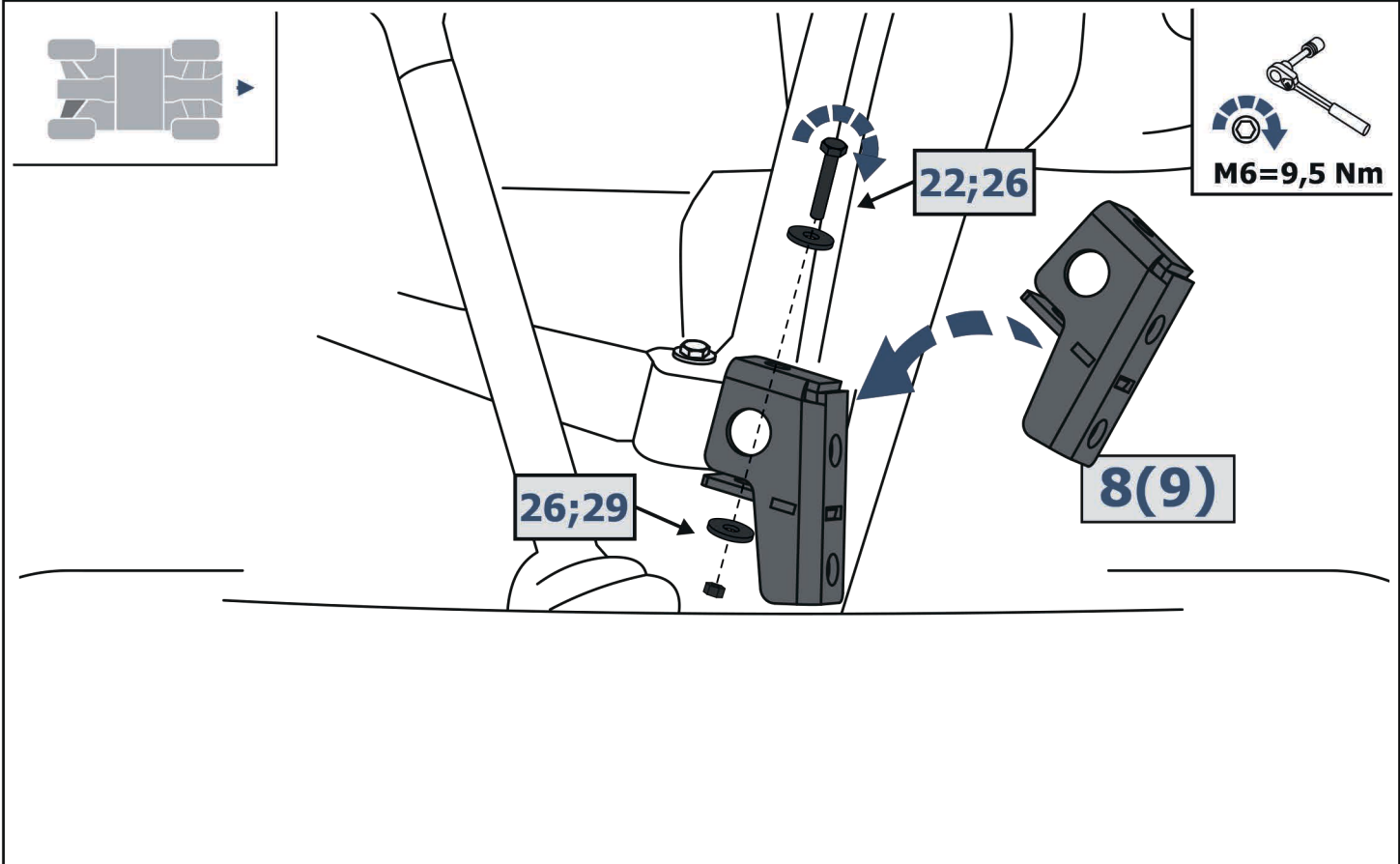
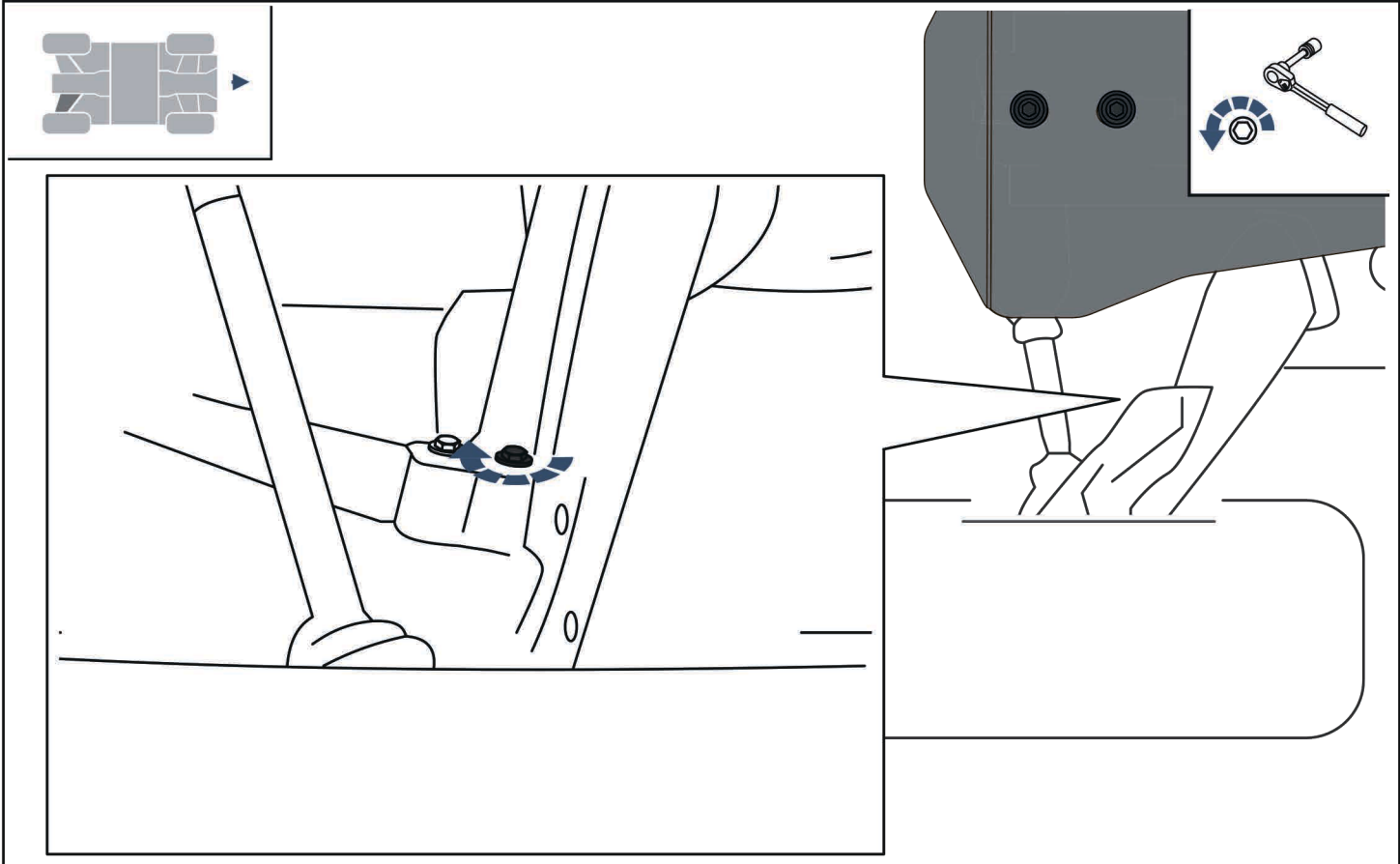

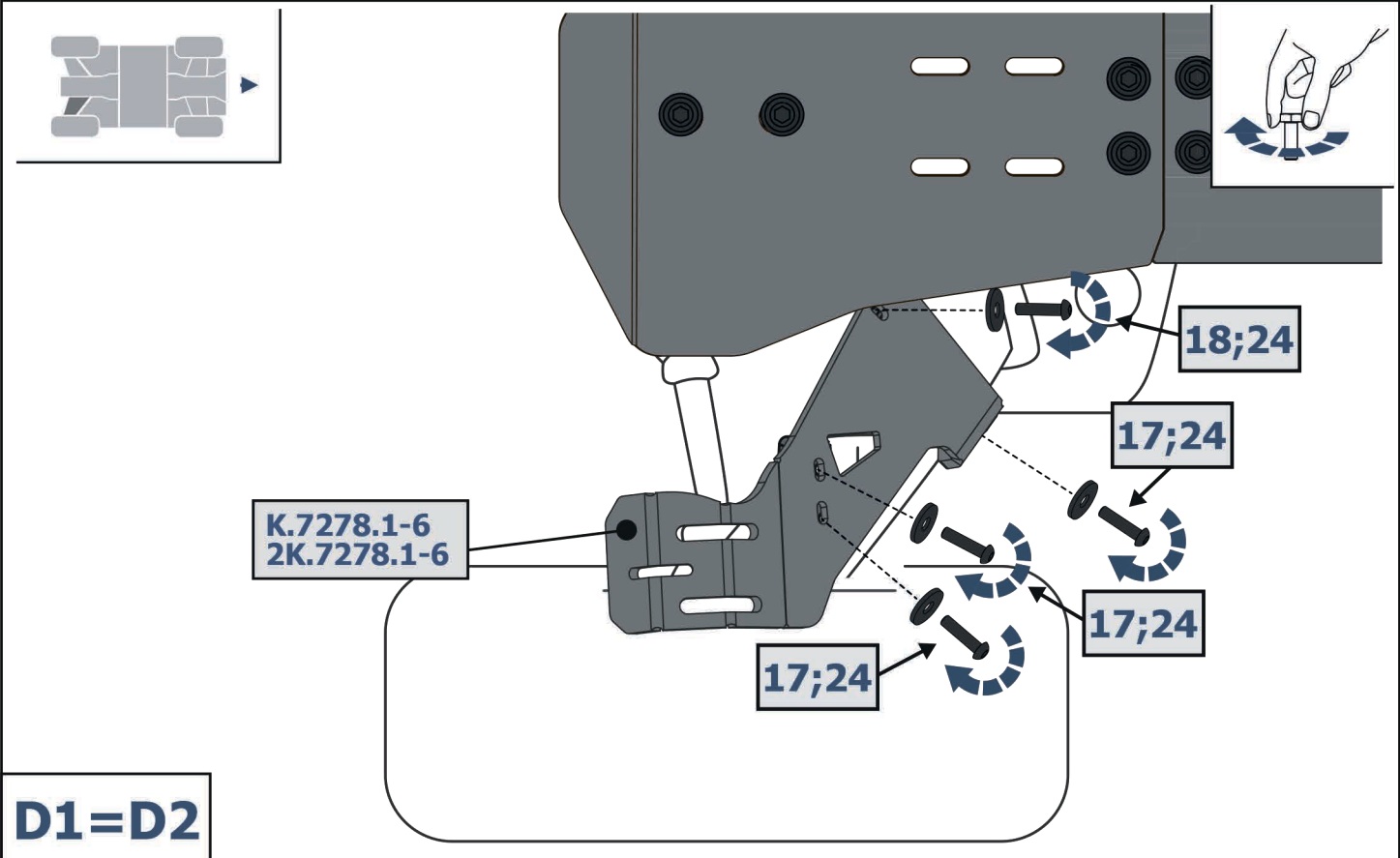
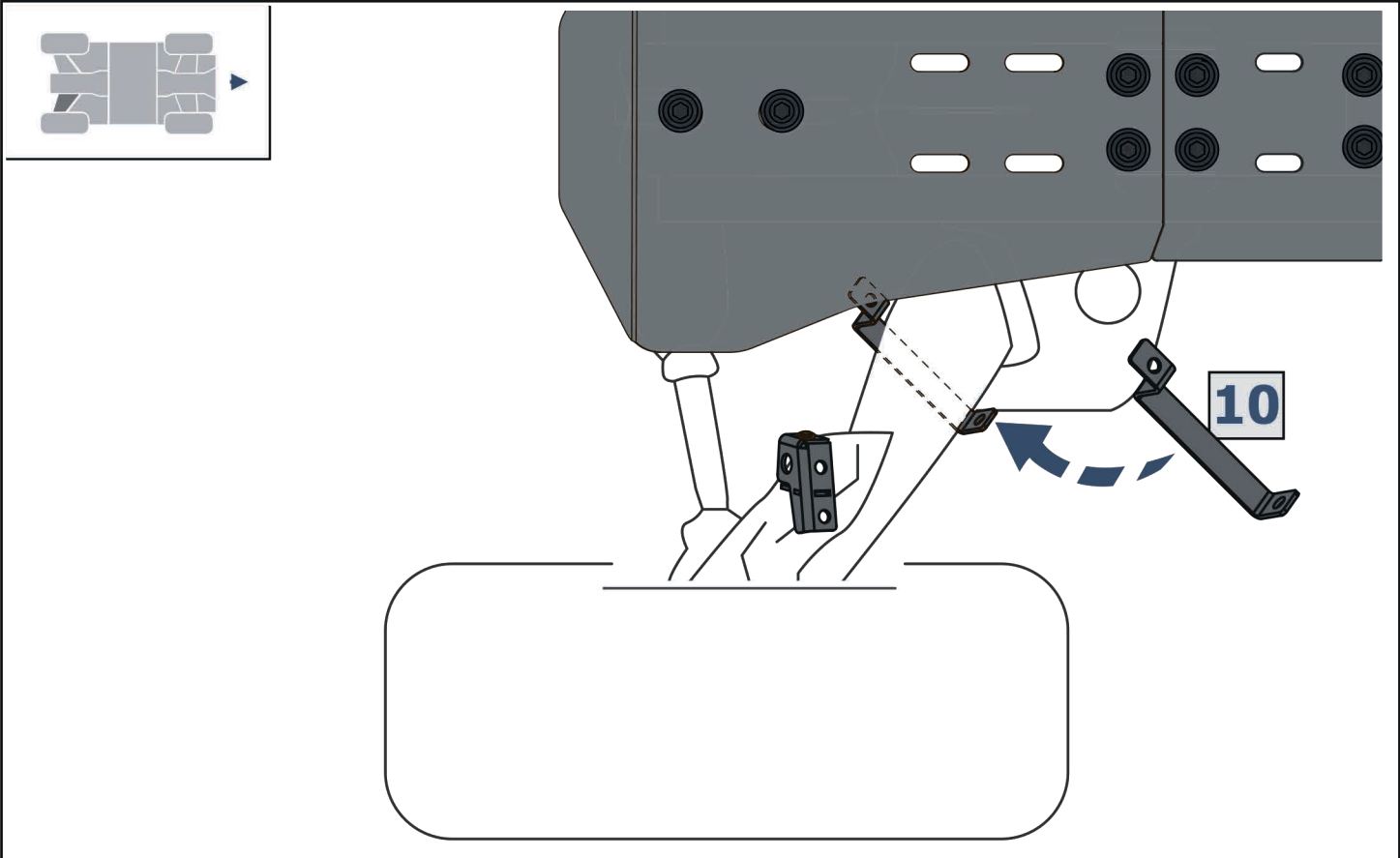

D1=D2

