

EN SKID PLATE INSTALLATION MANUAL

DE MONTAGEEINLEITUNG FÜR UNTERBODENSCHUTZSYSTEM

RU ИНСТРУКЦИЯ ПО УСТАНОВКЕ КОМПЛЕКТА ЗАЩИТ



For: BRP Can-Am Outlander L 450, 500 (2015-)

2444.7278.1;
444.7278.1



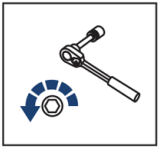

EN Regular fasteners
DE Originale montageteile
RU Штатный крепеж

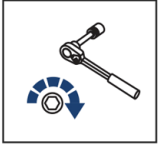

EN Regular fasteners
DE Originale montageteile
RU Штатный крепеж



EN Screw a several turns
DE Für wenigen Umdrehungen befestigen
RU Вкрутить на несколько оборотов



EN Loosen bolts
DE Bolzen lockern
RU Выкрутить на несколько оборотов

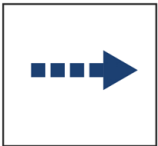

EN Movement Arrow
DE Bewegungsrichtung
RU Движение

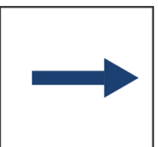

EN Location/Position Arrow
DE Anordnung/Positionsrichtung
RU Расположение



EN Screw Arrow
DE Drehungsrichtung
RU Поворот

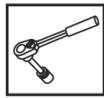

EN Ratchet
DE Ratsche
RU Трещётка

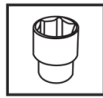



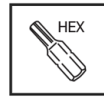



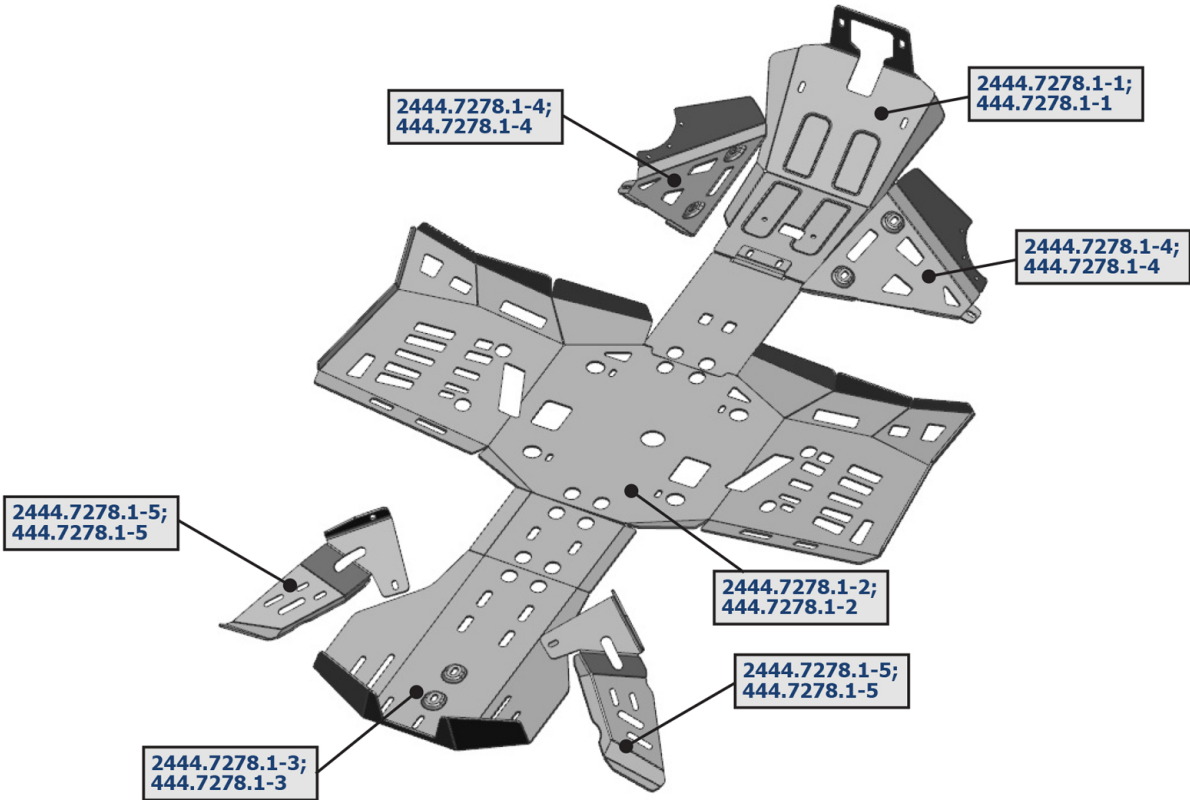

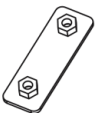
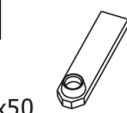
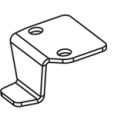
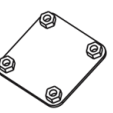



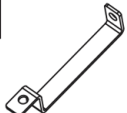
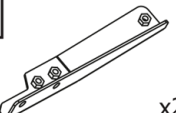
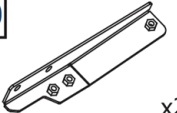
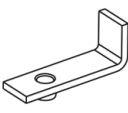
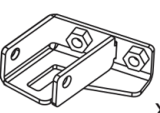
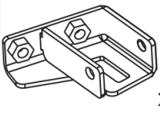
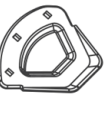
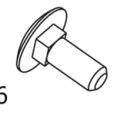

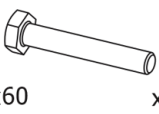

S - 10;
S - 13

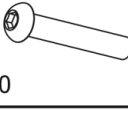

S - 5

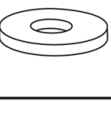
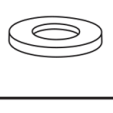
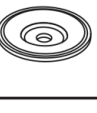

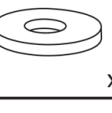
1  x1	2  M8x50 x10	3  x2	4  x1	5  x1	6  M8 x2
7  x4	8  x2	9  x2	10  x2	11  M8 x4	12  x1
13  x1	14  x2	15  M6x16 x6	16  x2	17  M6x60 x2	18  M8x20 x8
19  M8x25 x22	20  M8x30 x4	21  M8x35 x4	22  M8x25 x8	23  M8x40 x2	24  M6 x8
25  M8 x2	26  Ø8 x22	27  Ø8 x10	28  M8 x18	29  Ø6 x6	30  Ø6 x10

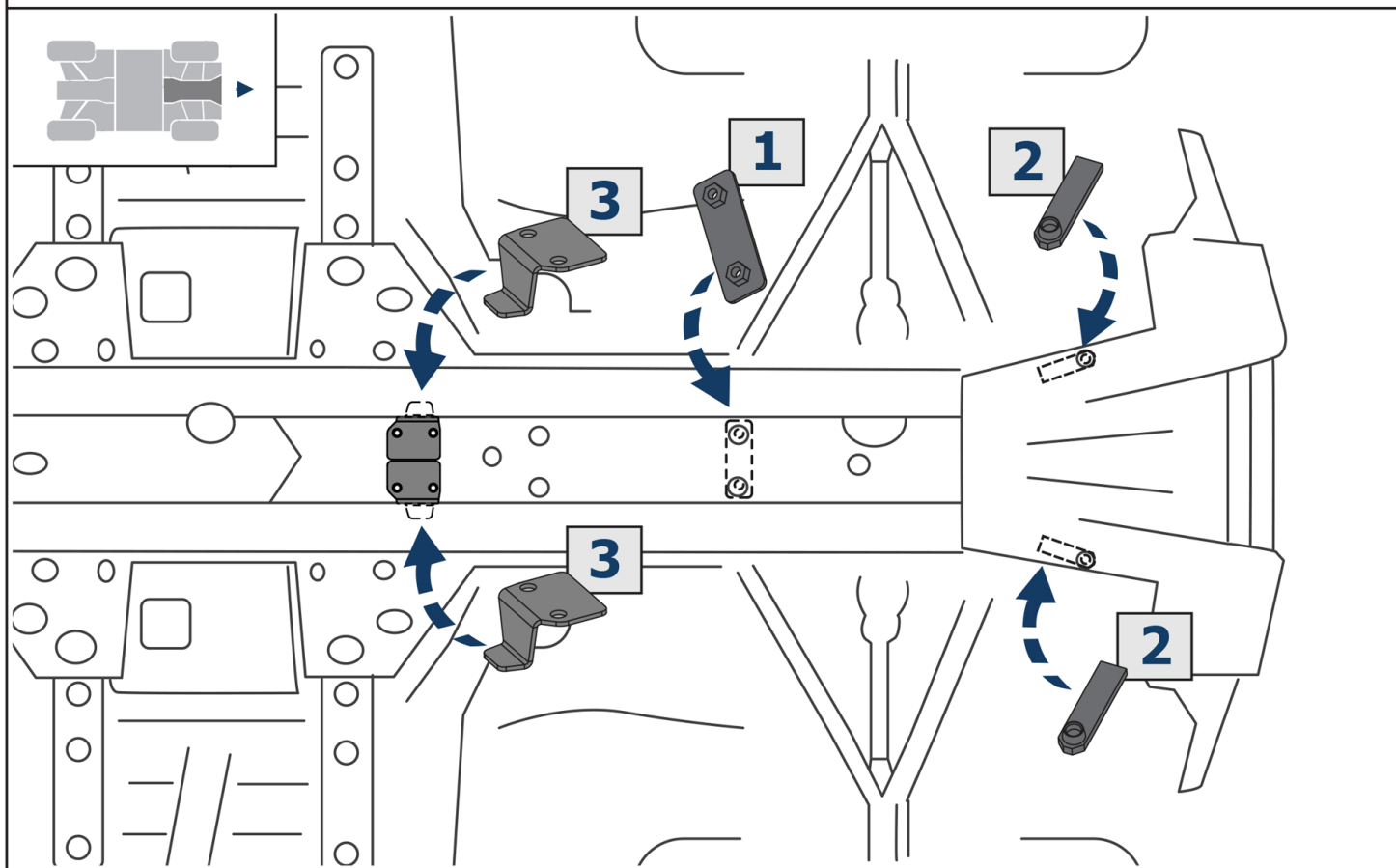
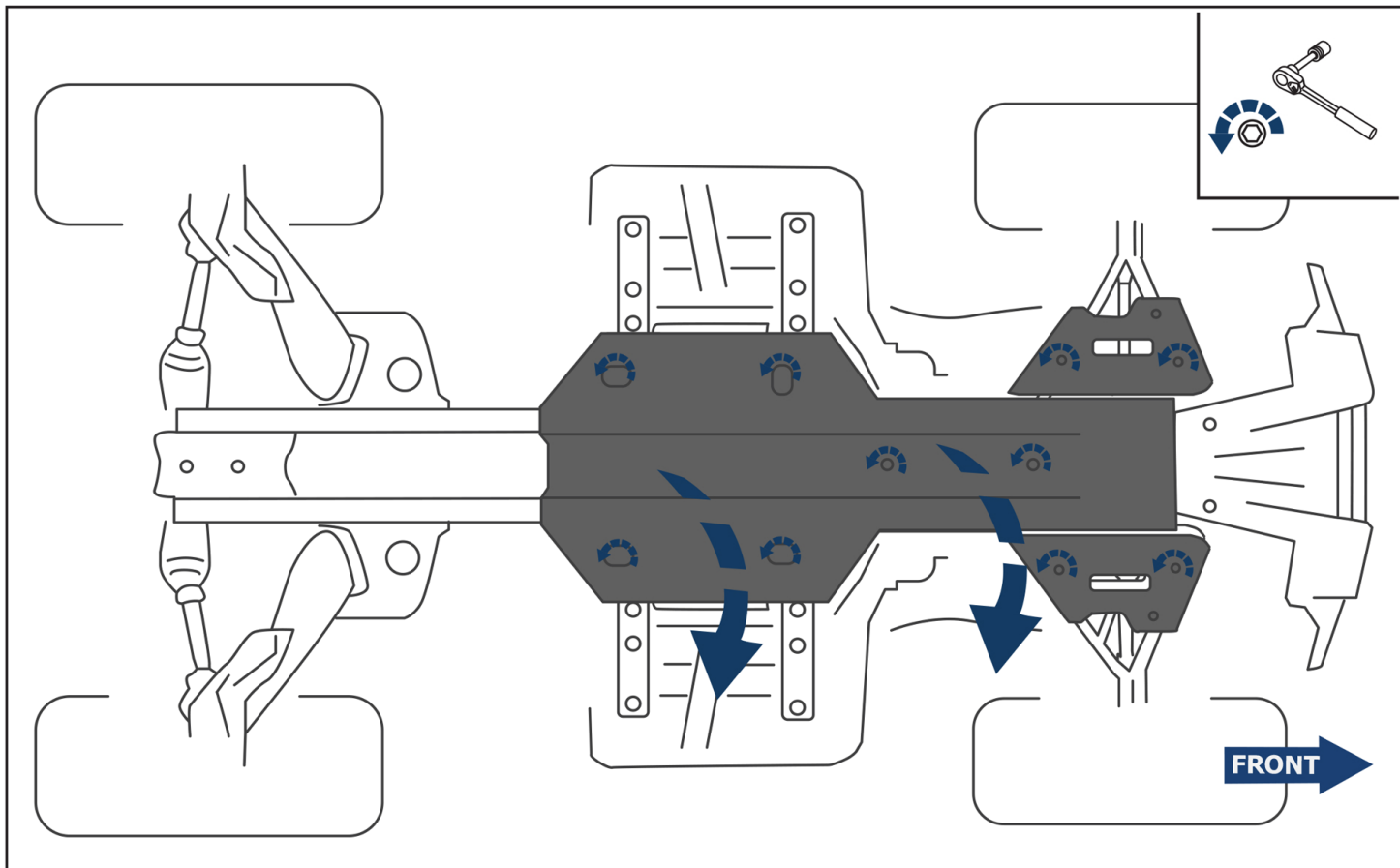

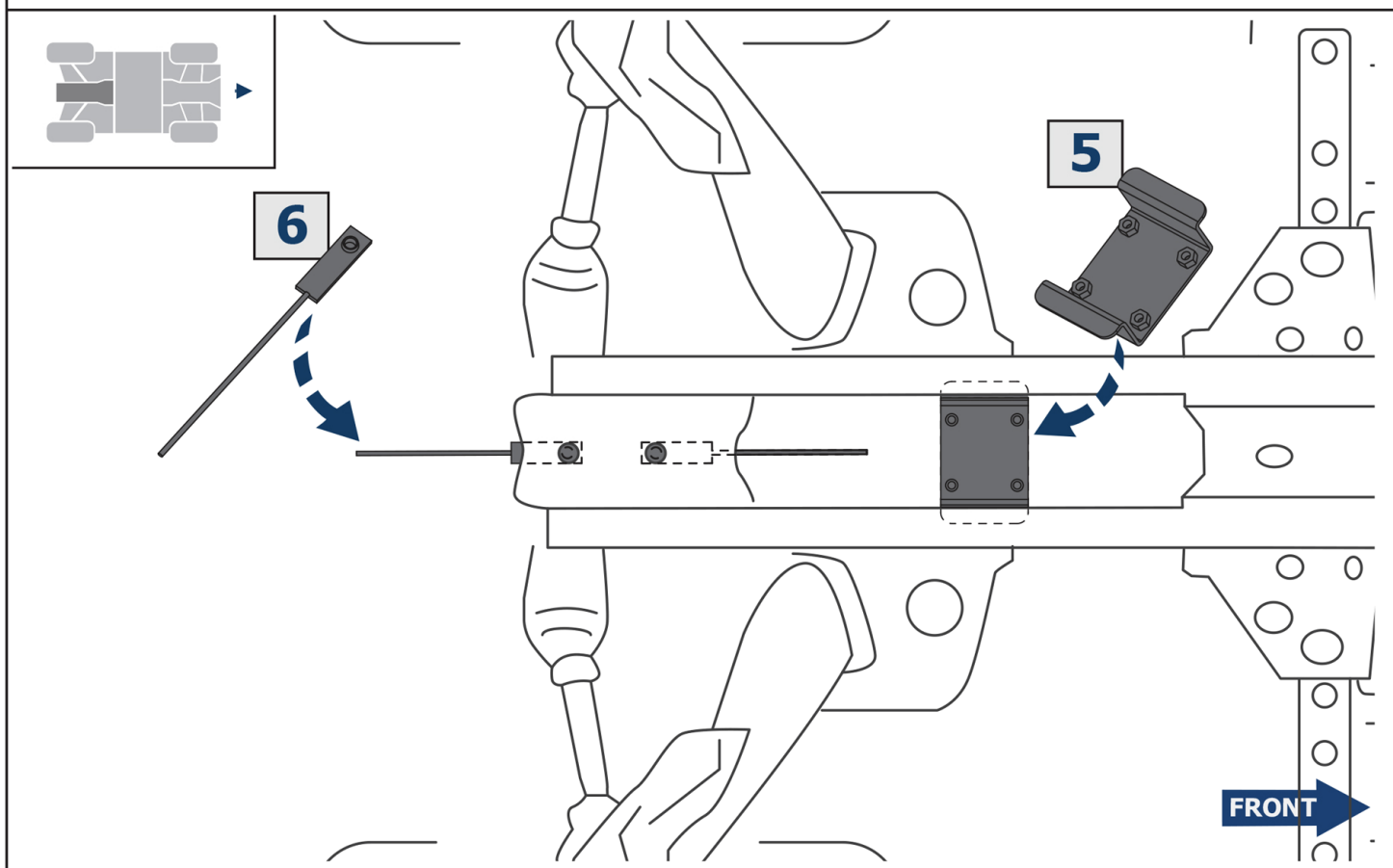
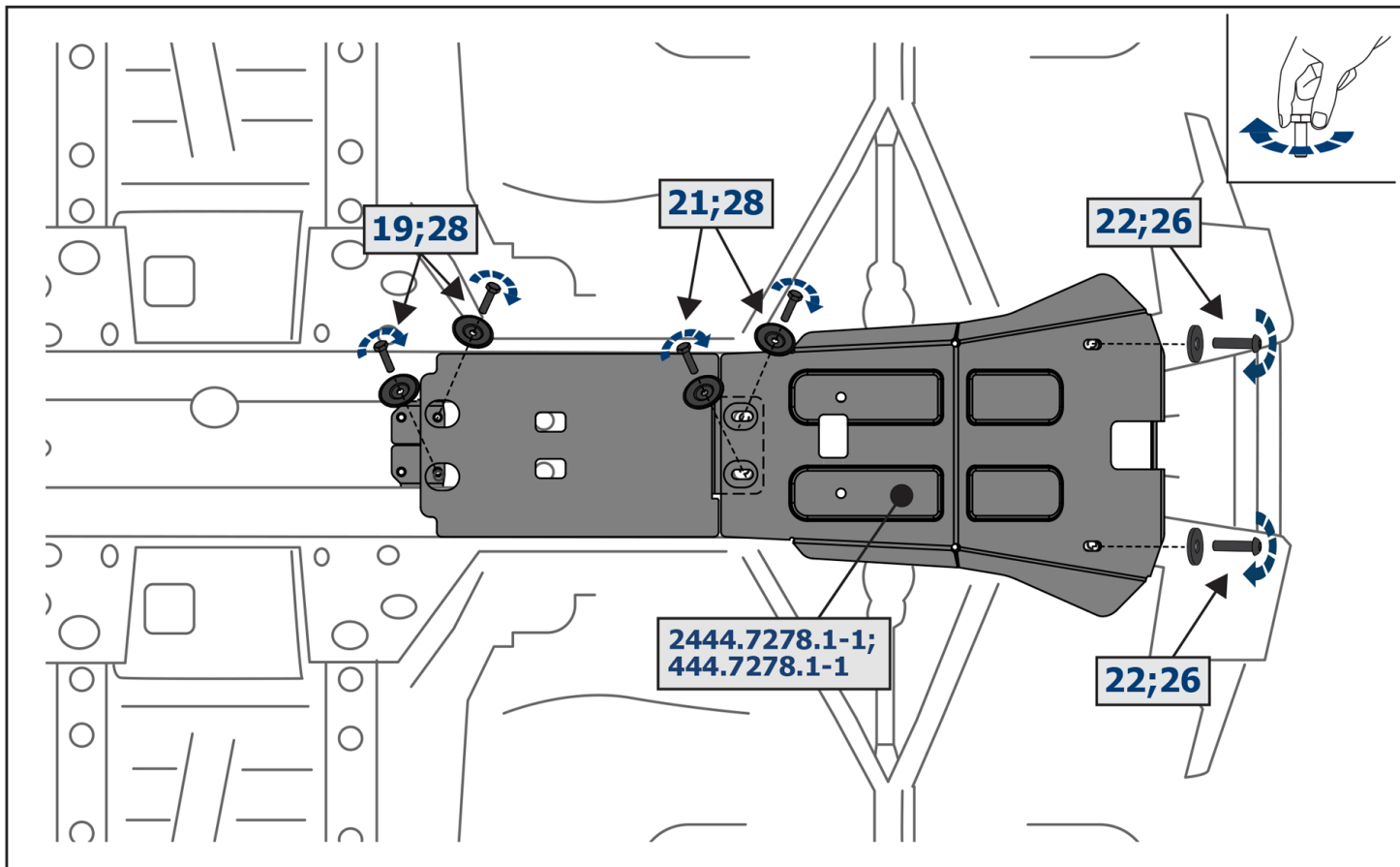

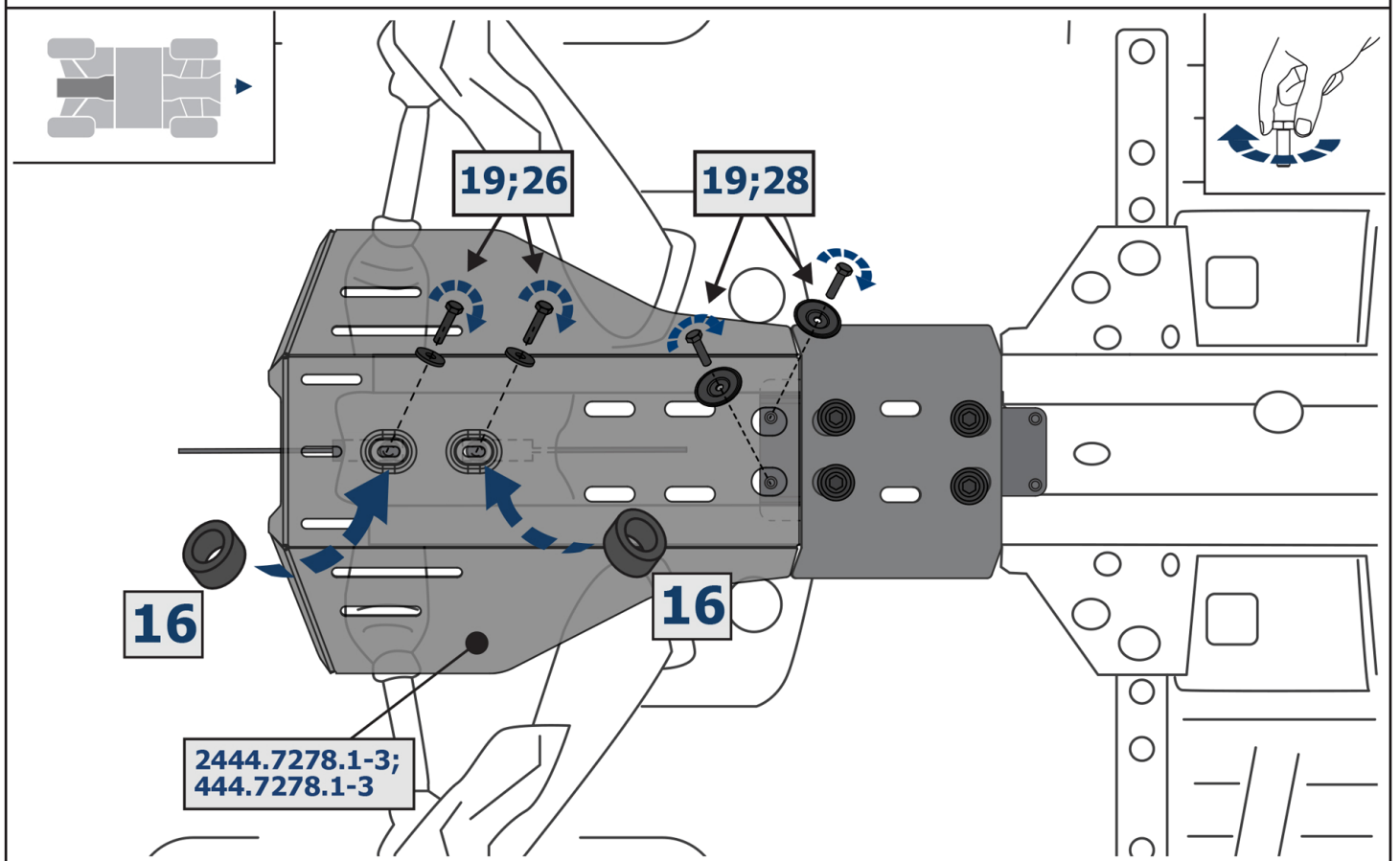
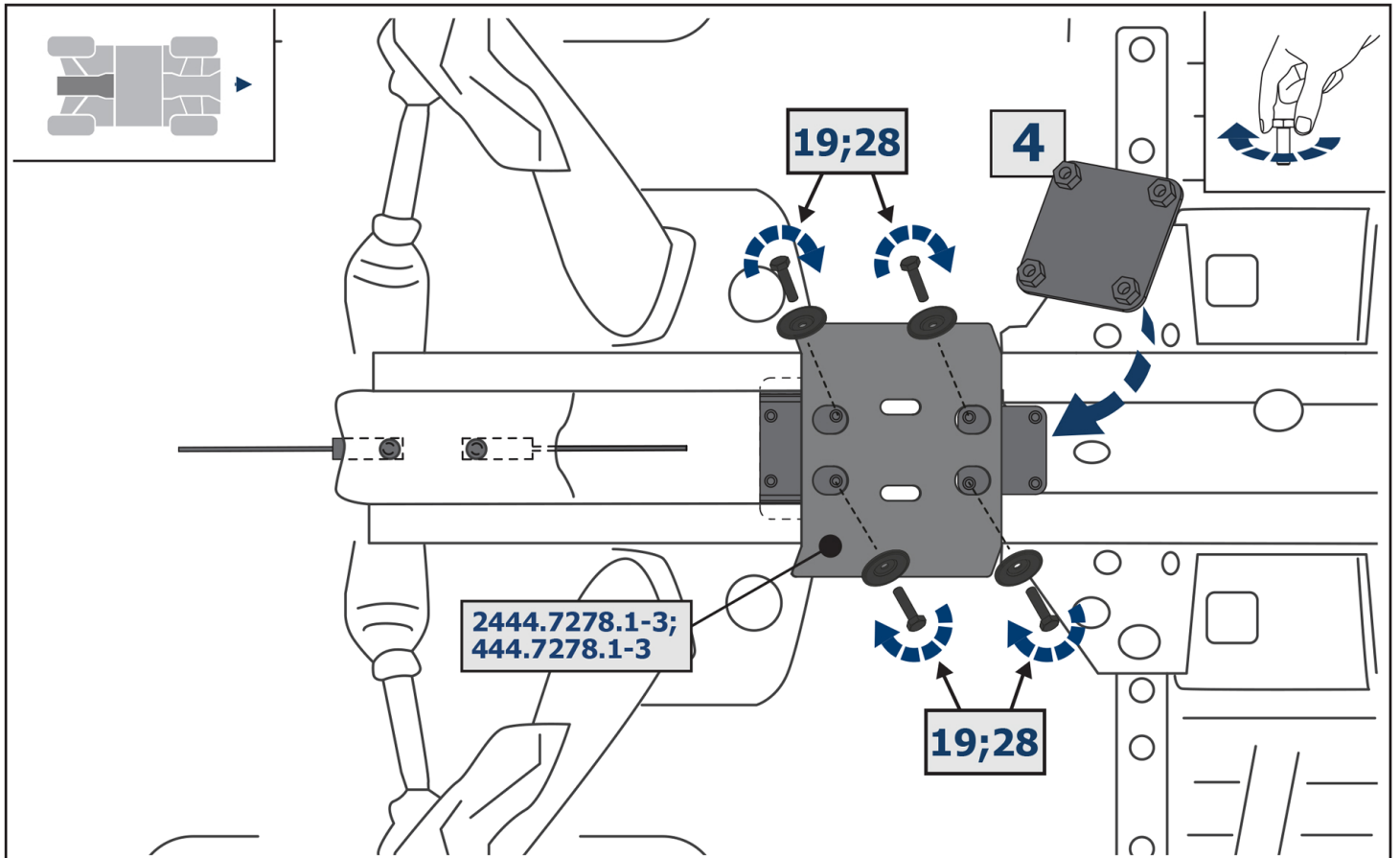

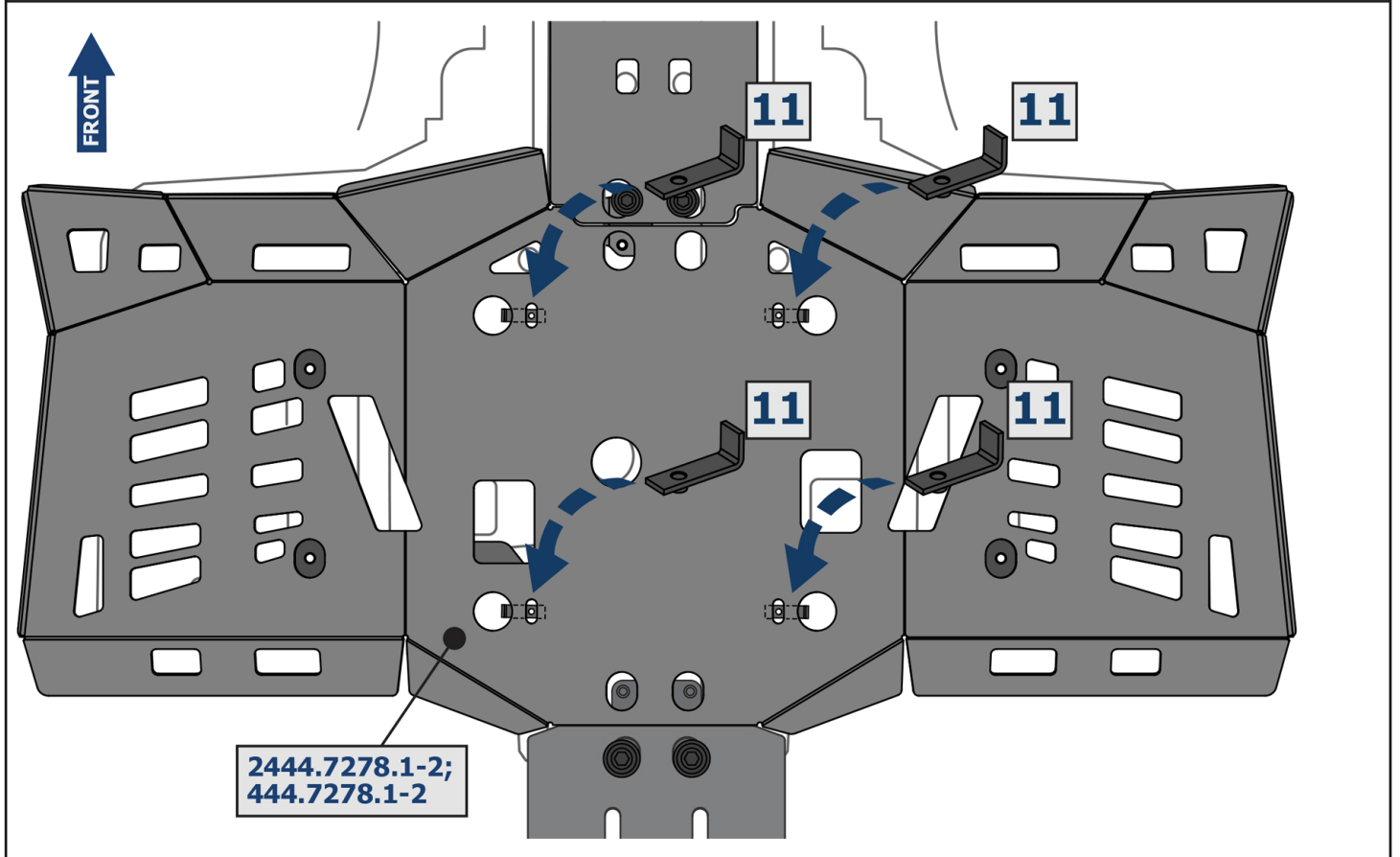
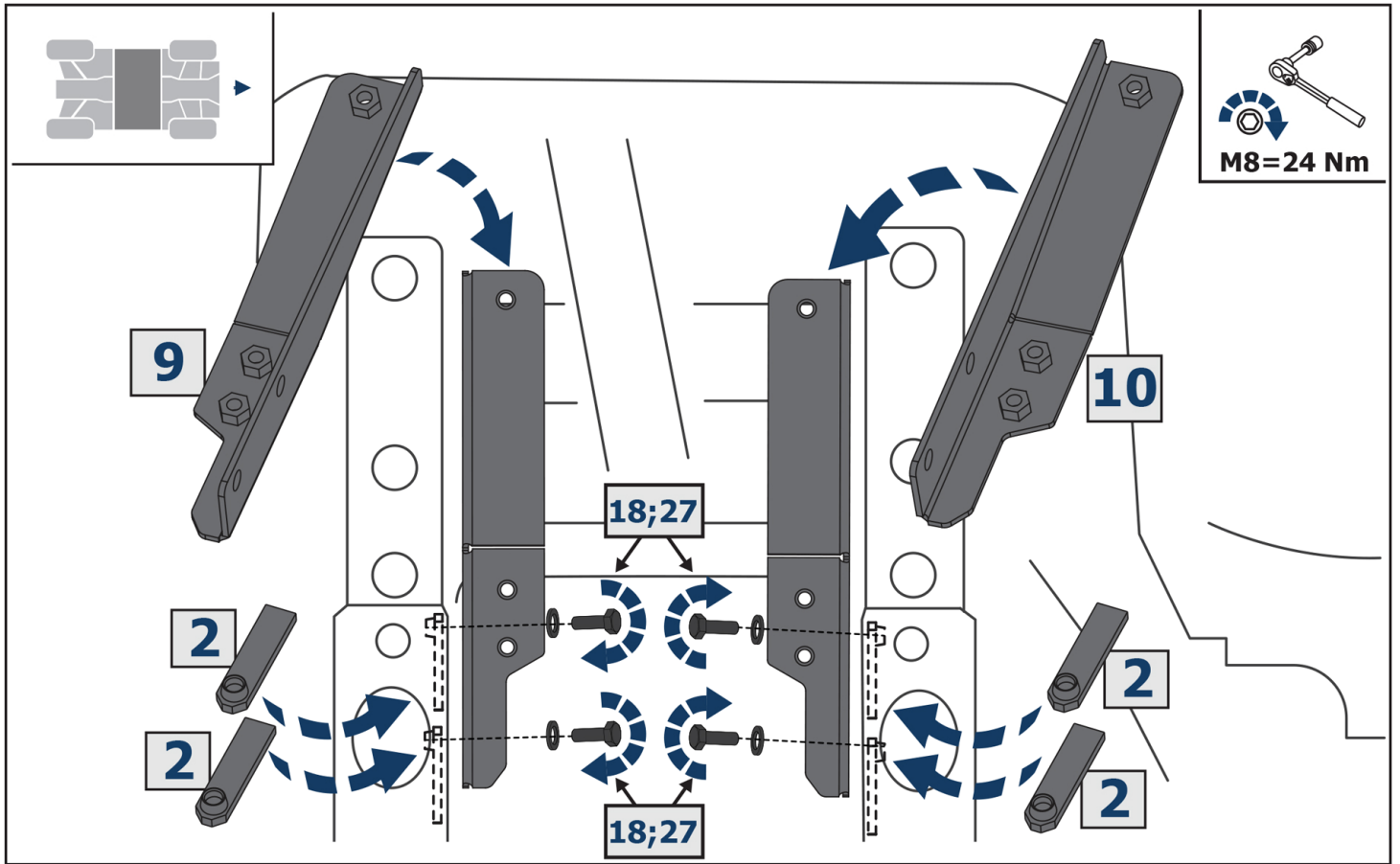

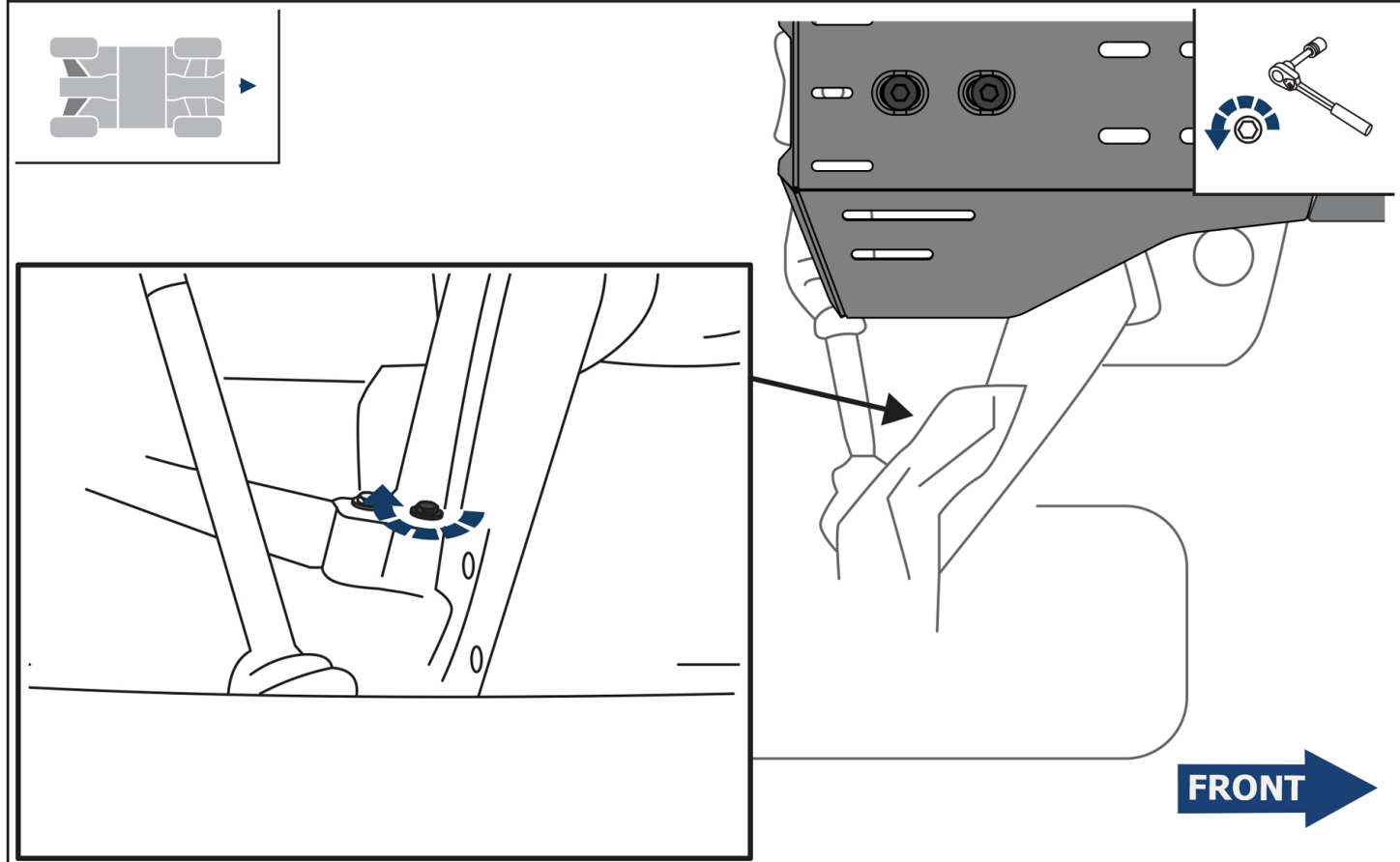
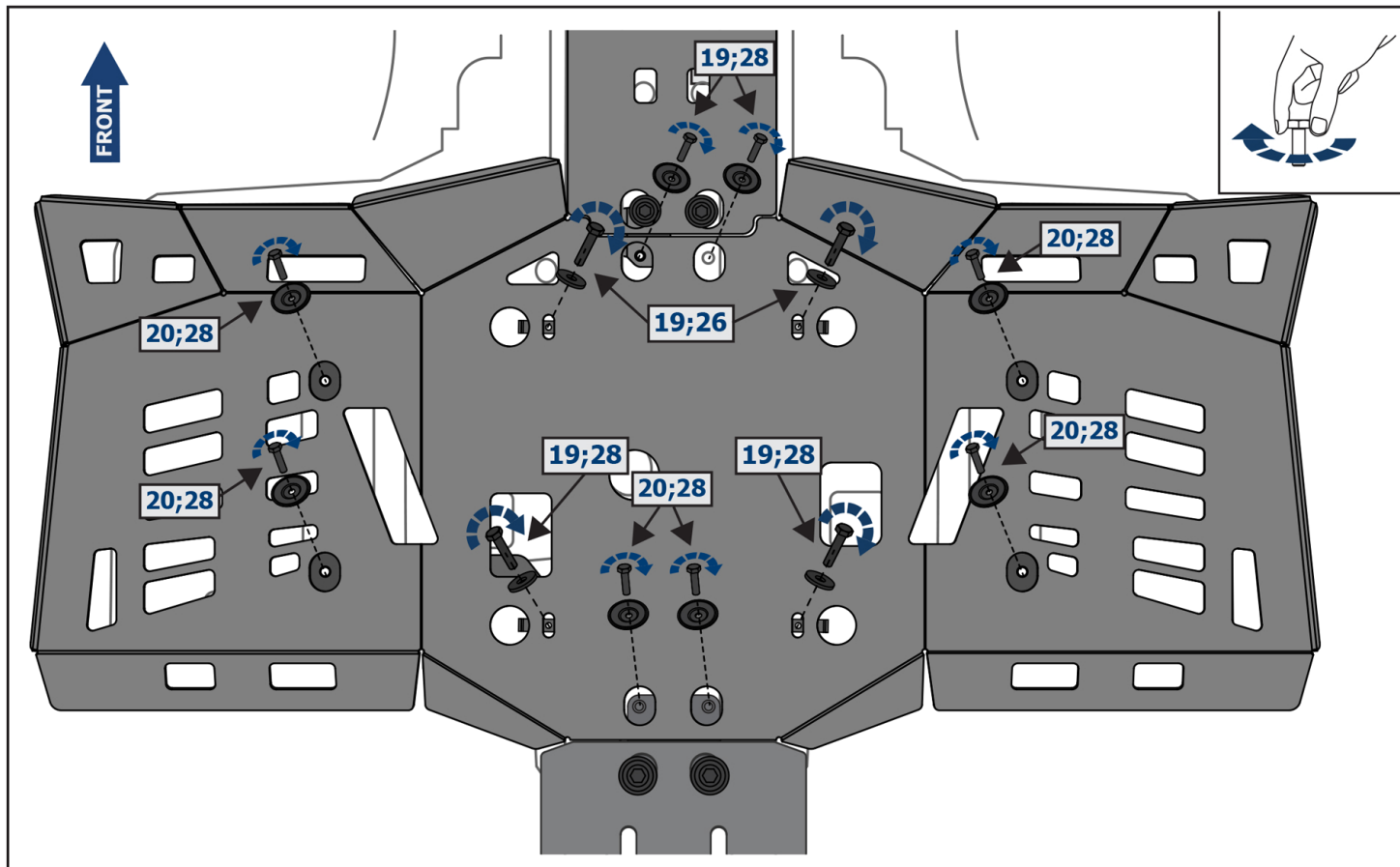

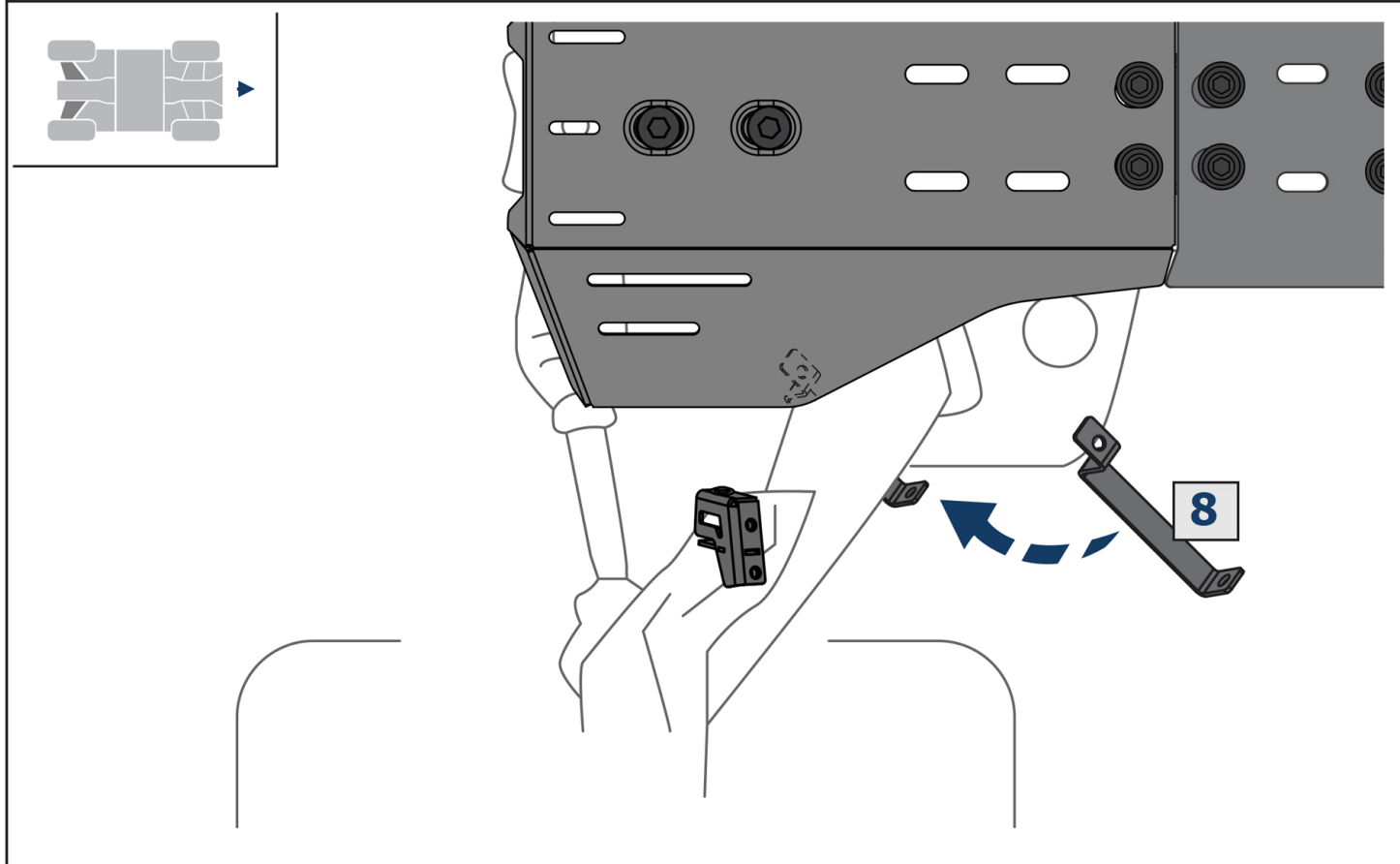
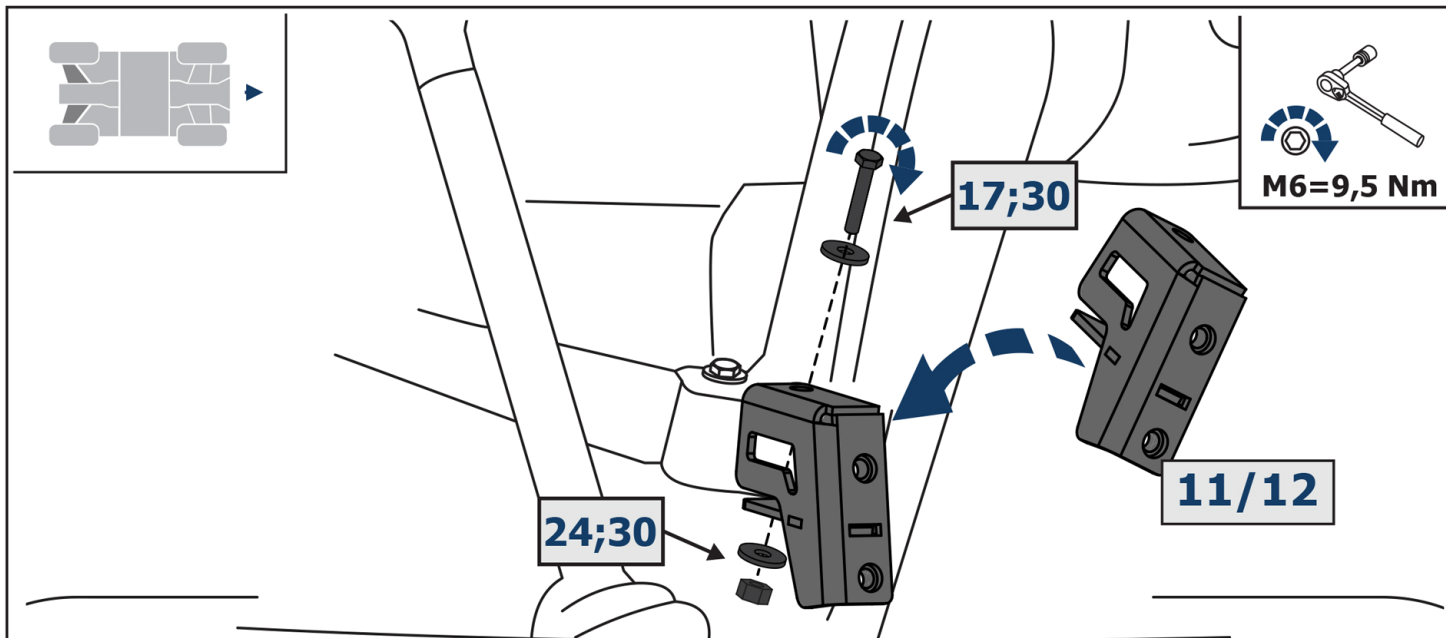

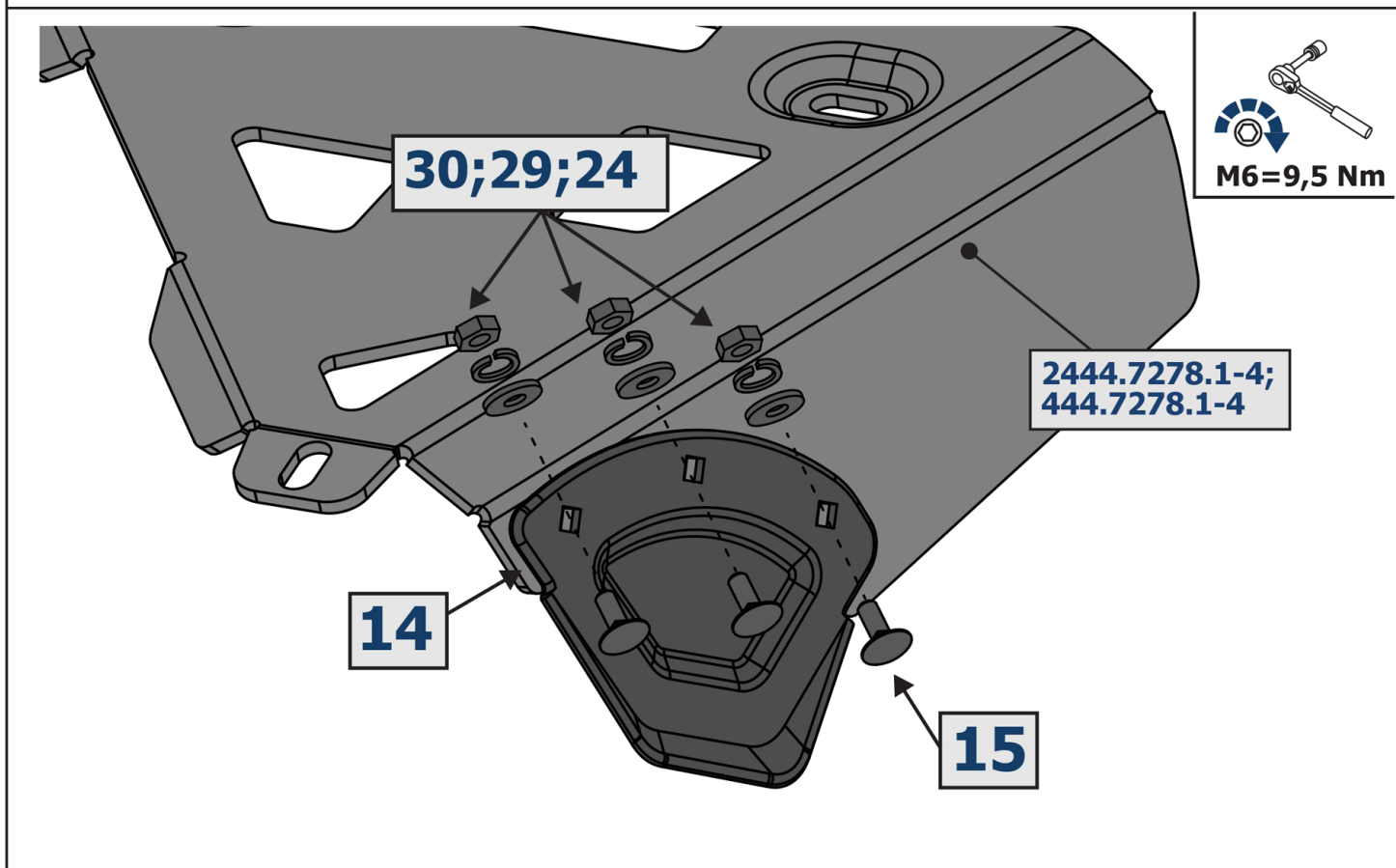
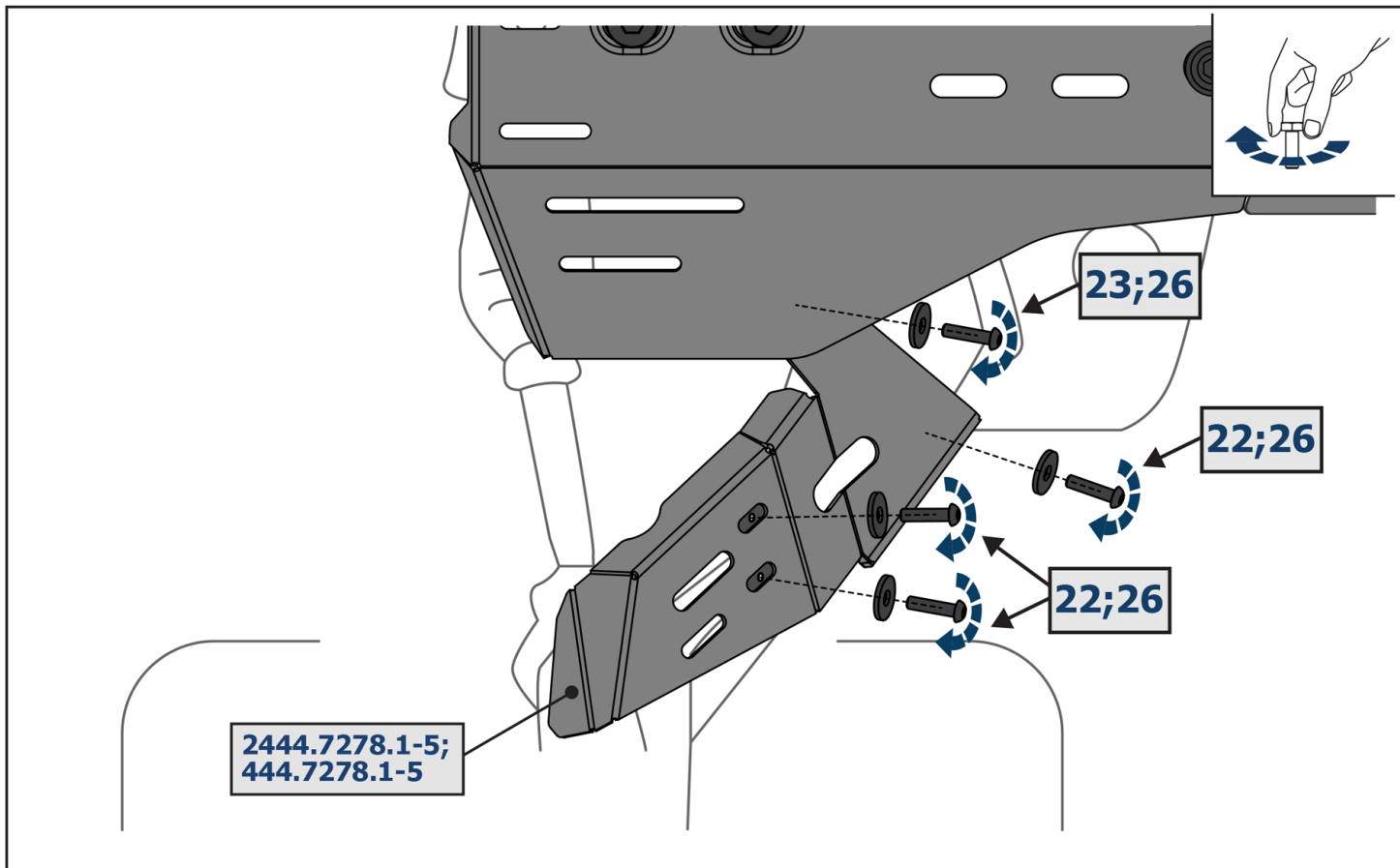

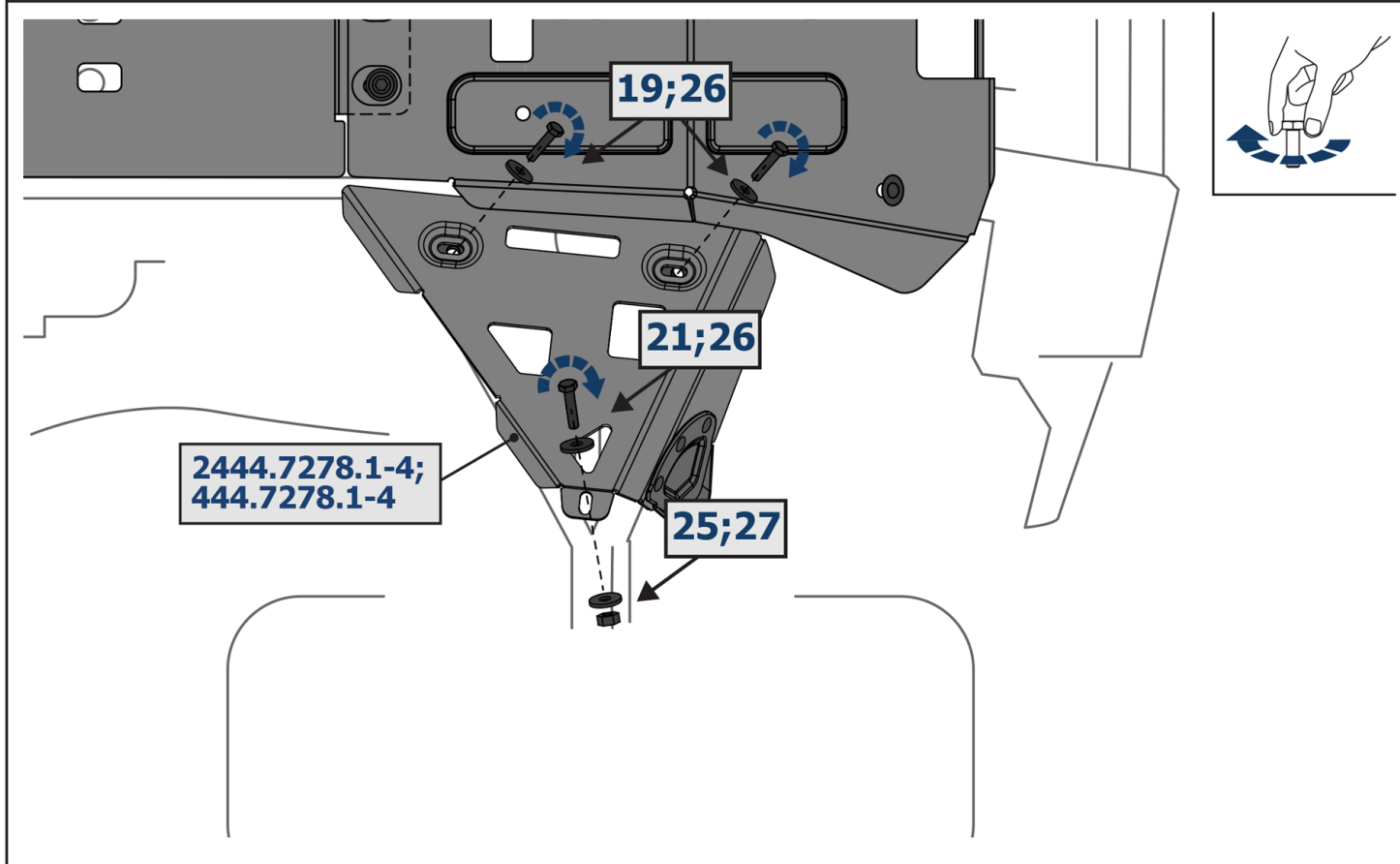
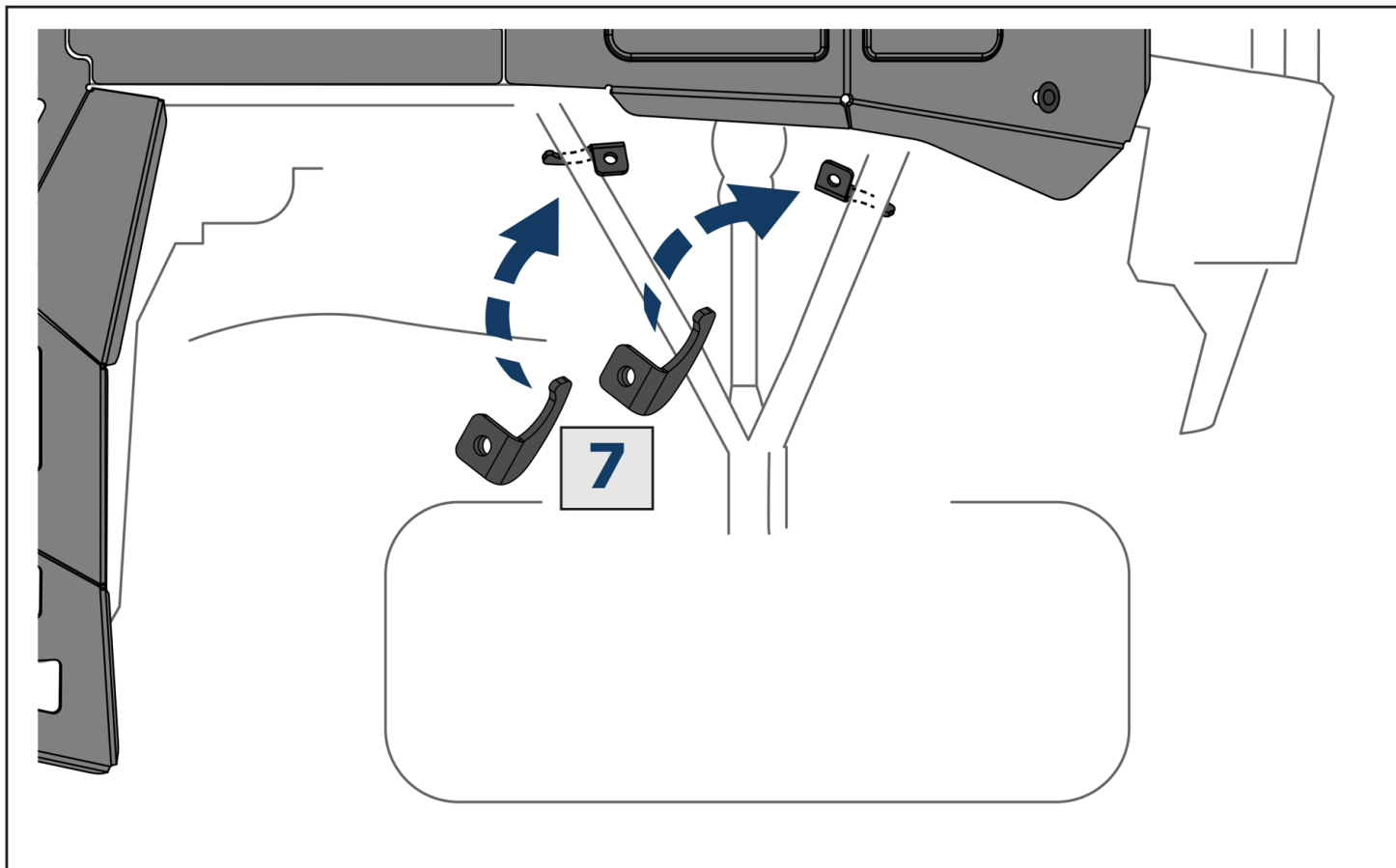



M8=24 Nm

