

**EN** SKID PLATE INSTALLATION MANUAL

**FR** MANUEL D'INSTALLATION DE PLAQUE DE PROTECTION

**DE** MONTAGEEINLEITUNG FÜR UNTERBODENSCHUTZSYSTEM

**RU** ИНСТРУКЦИЯ ПО УСТАНОВКЕ КОМПЛЕКТА ЗАЩИТ



**For: Yamaha Grizzly 700 (2016-)**

**2444.7124.1**

**444.7124.1**



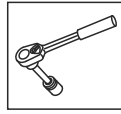



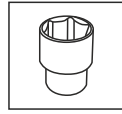



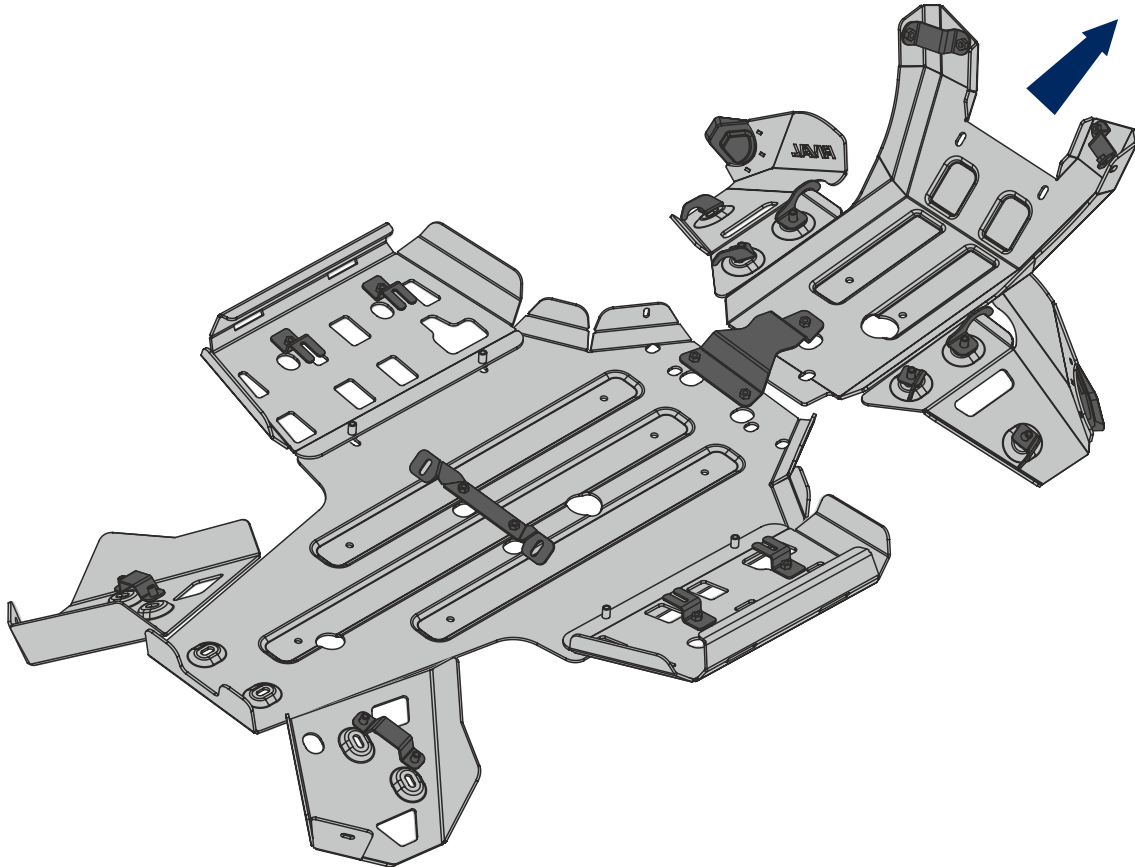

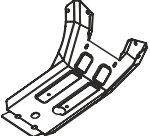
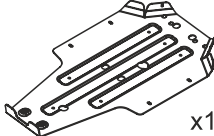
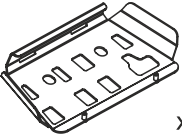
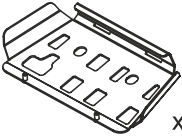
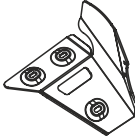



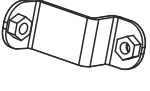
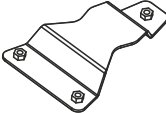
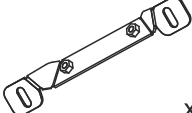

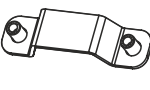
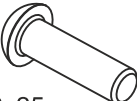
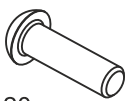
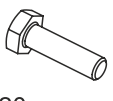
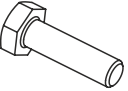
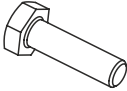
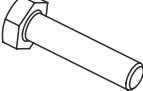
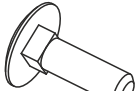

EN Ratchet  
FR Clé À Cliquet  
DE Ratsche  
RU Трещетка



S - 10;  
S - 13



 x1	 x1	 x1	 x1	 x1	 x1
 x1	 x1	 x2	 x1	 x1	 x4
 x4	 x2	 x2	 M8x25 x8	 M6x20 x2	 M6x20 x8
 M8x25 x16	 M8x35 x3	 M8x50 x2	 M6 x6	 Ø 8 x11	 Ø 6 x6
 Ø 6 x18	 Ø 8 x20	 M6 x8	 M8 x2	 x1	 x1

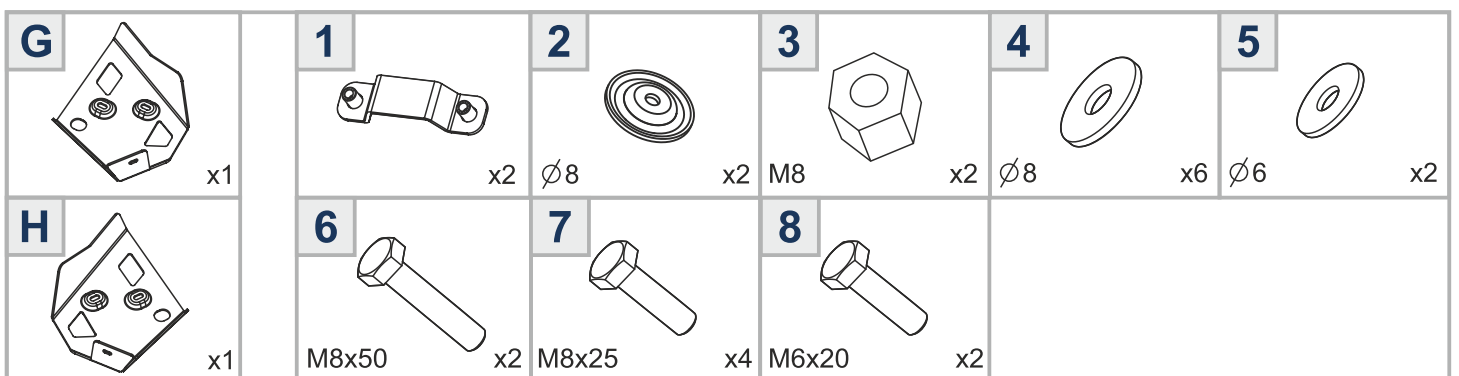
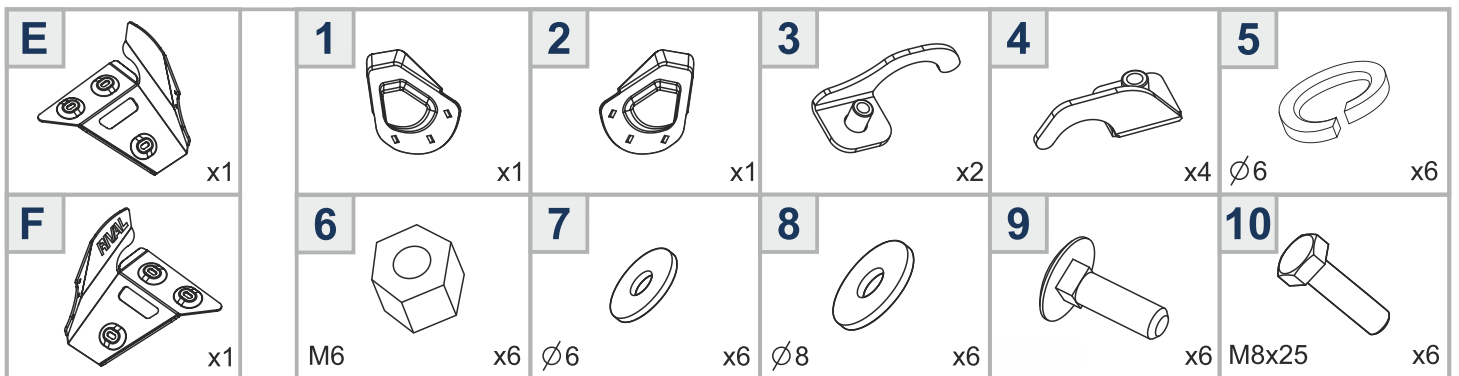
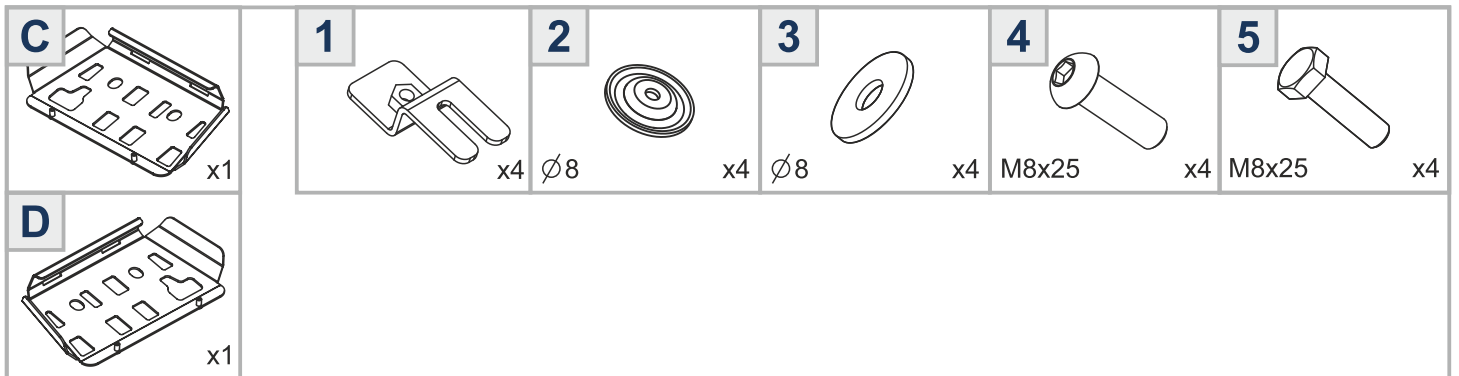
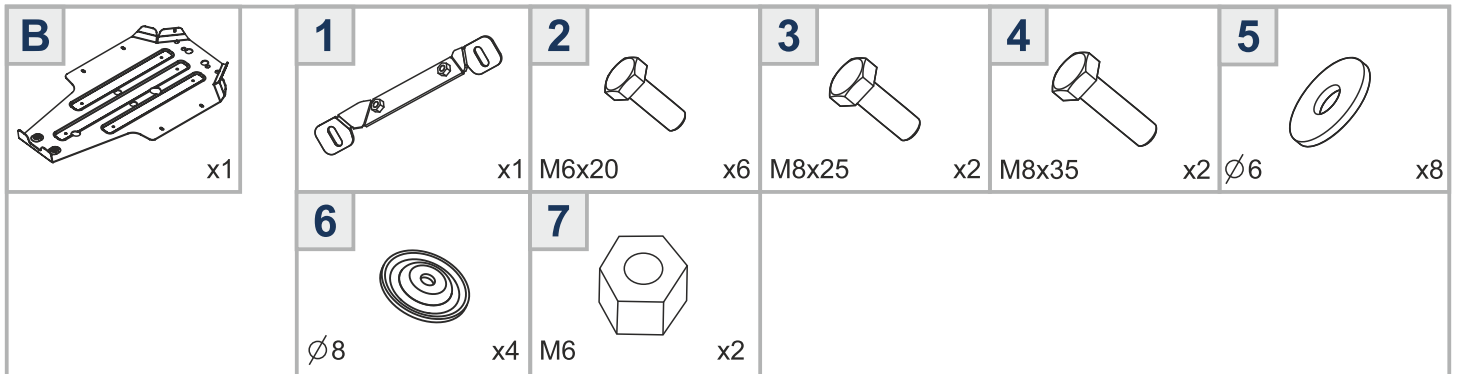
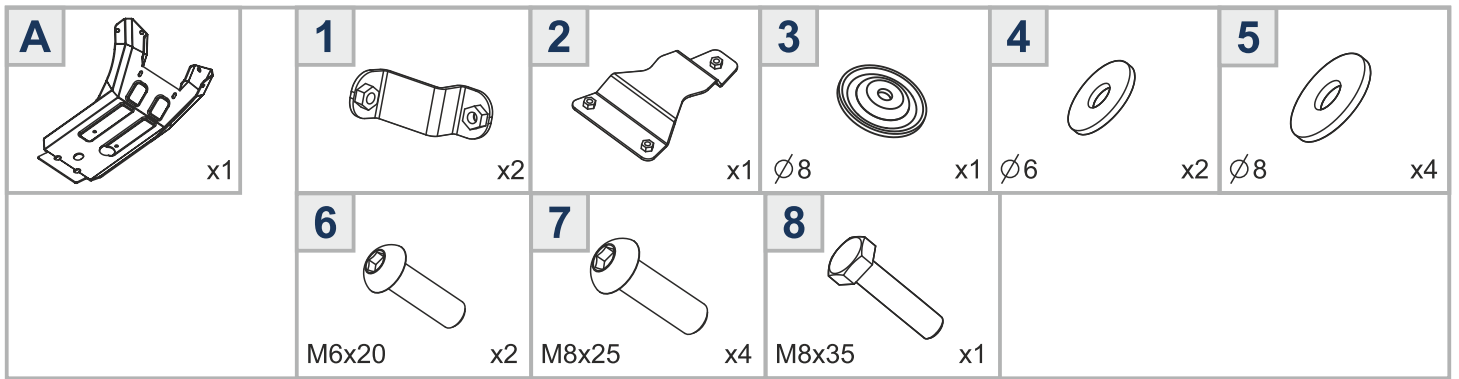

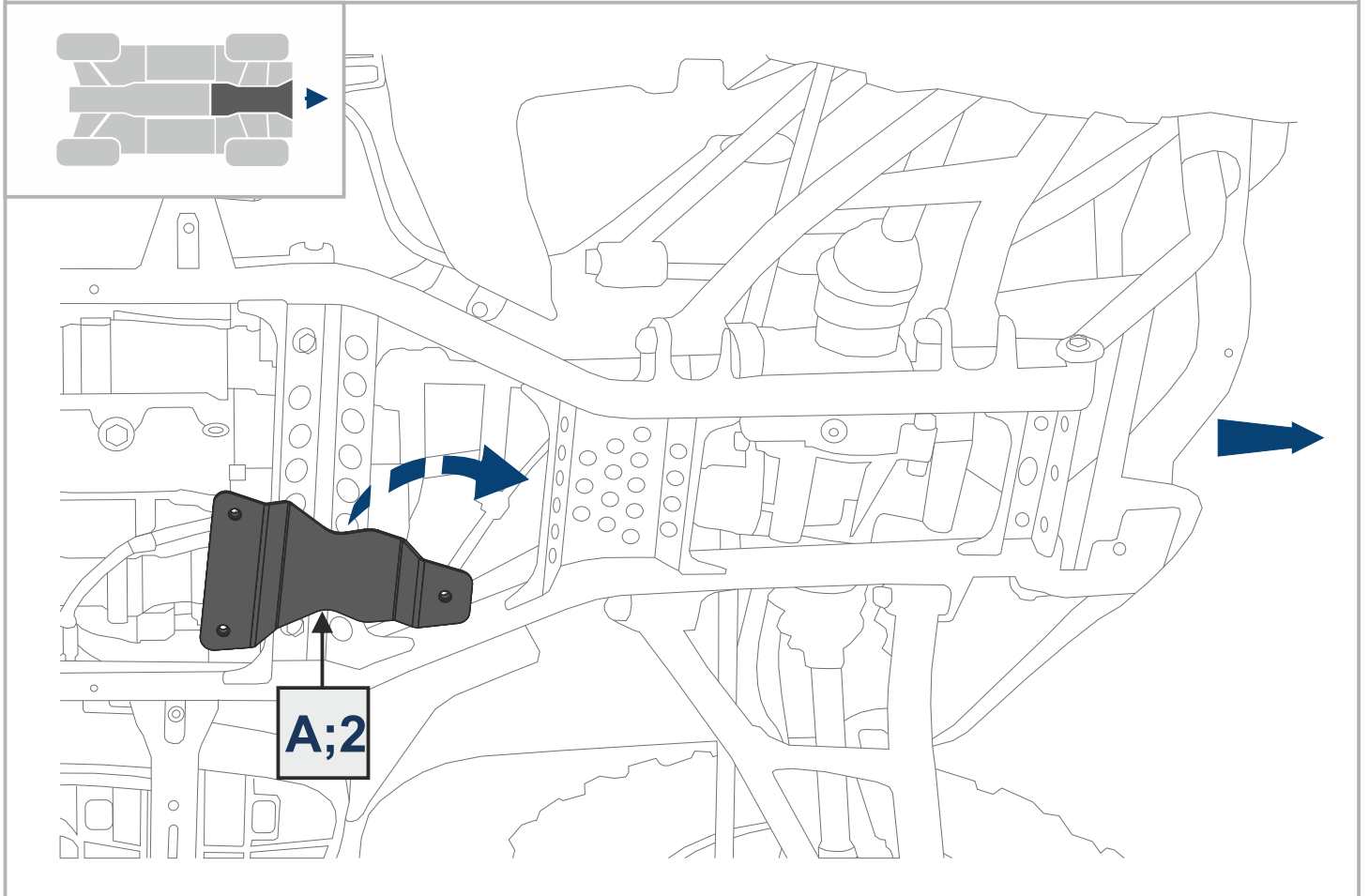
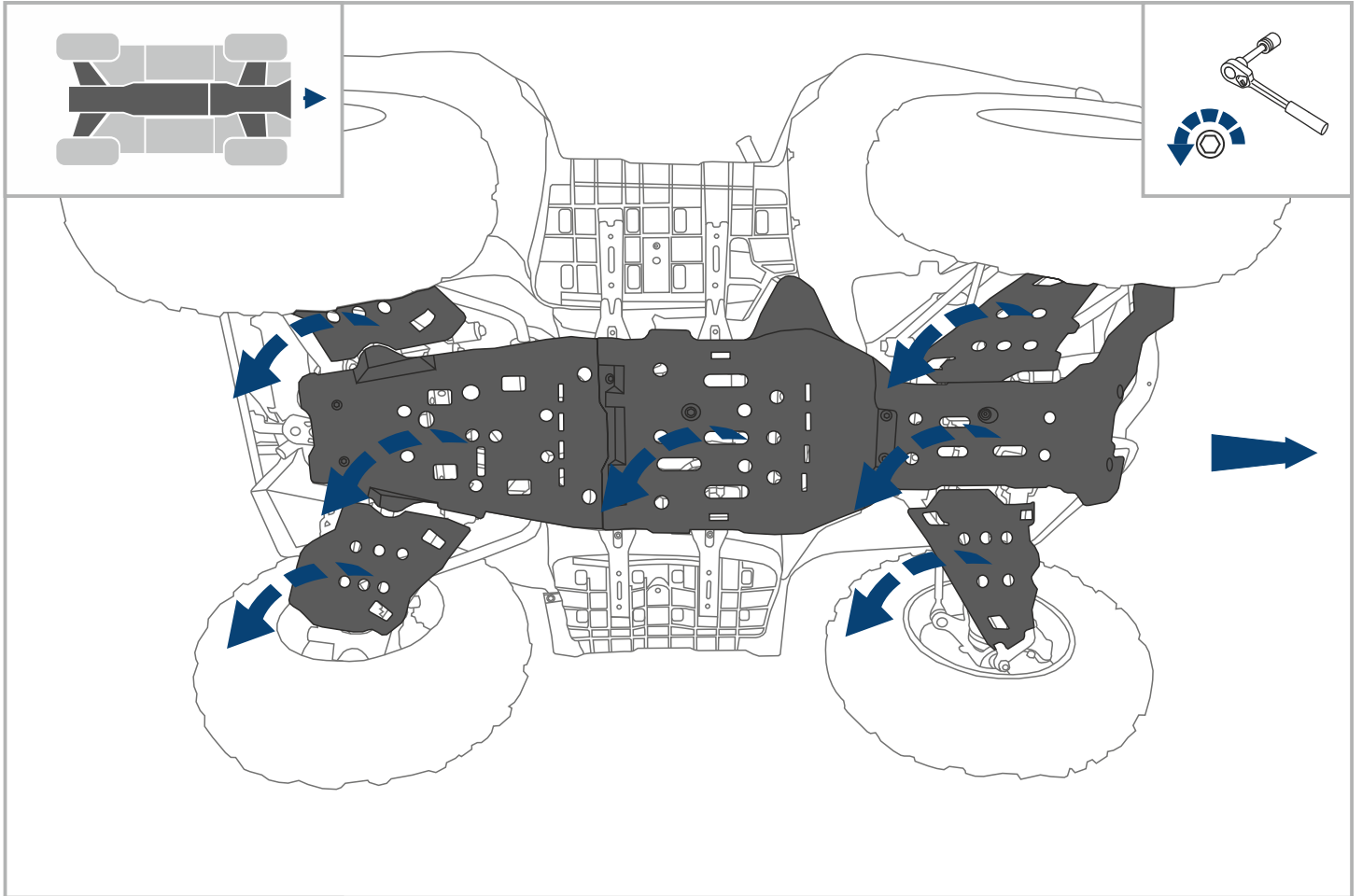

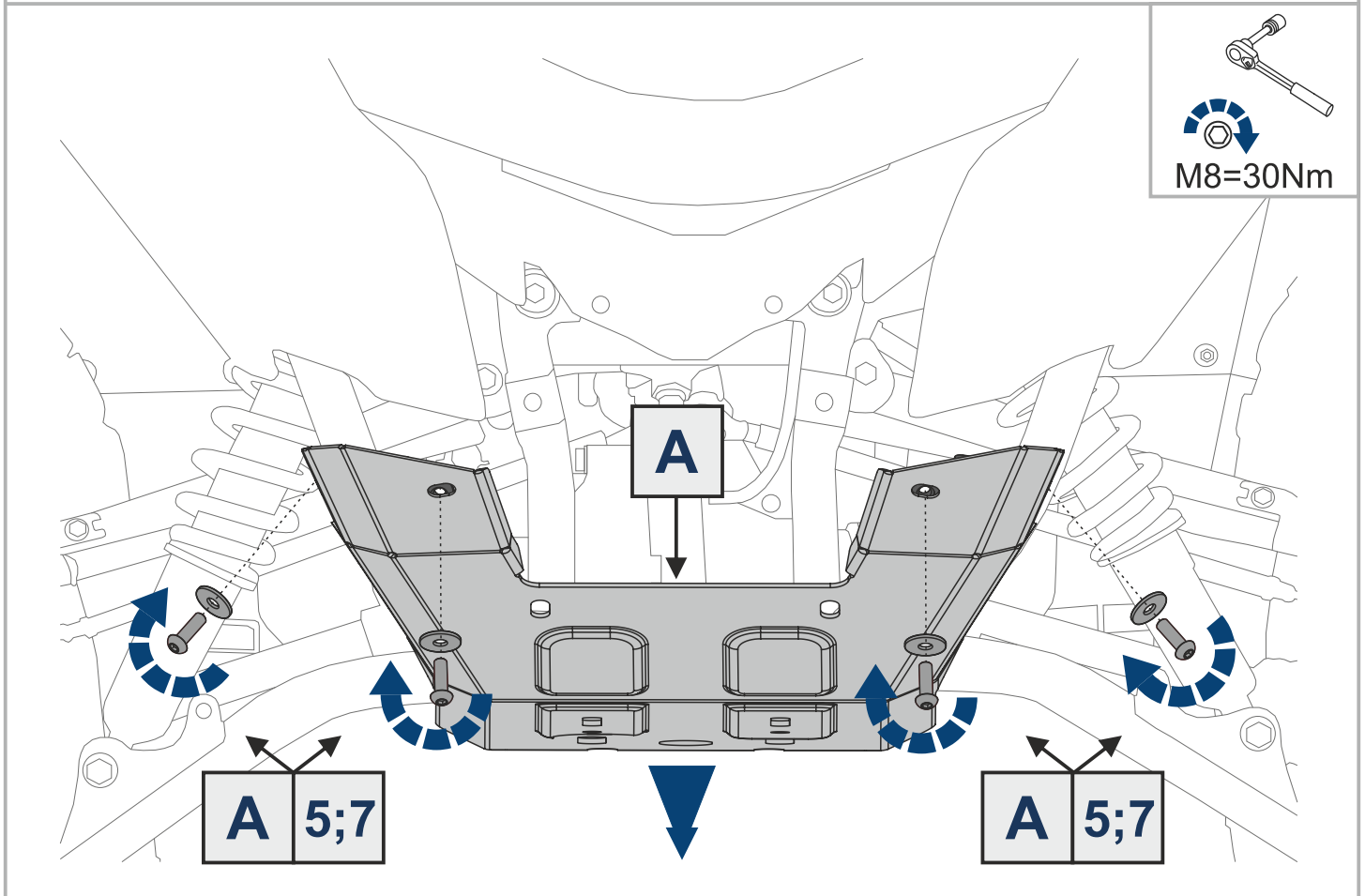
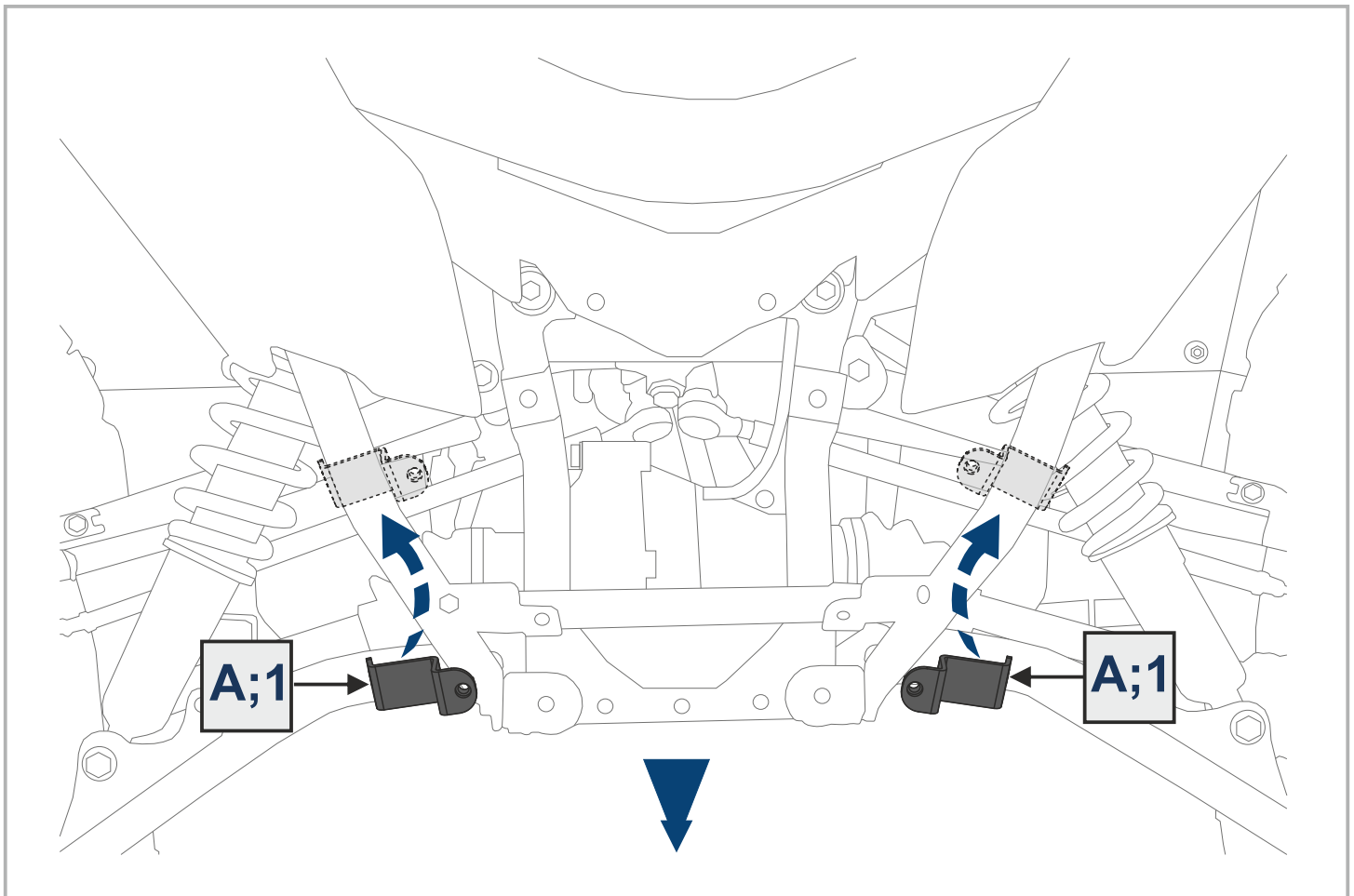

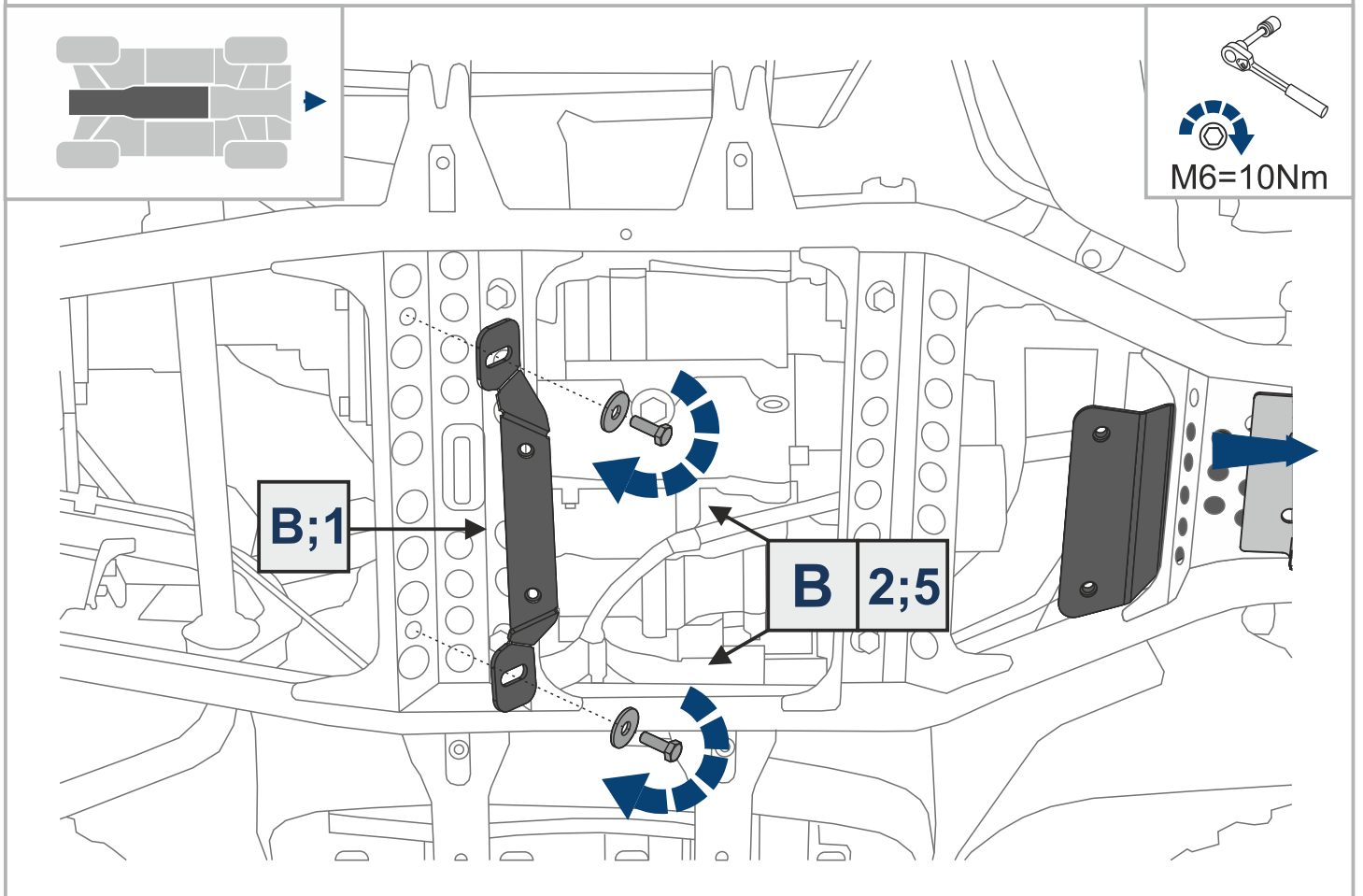
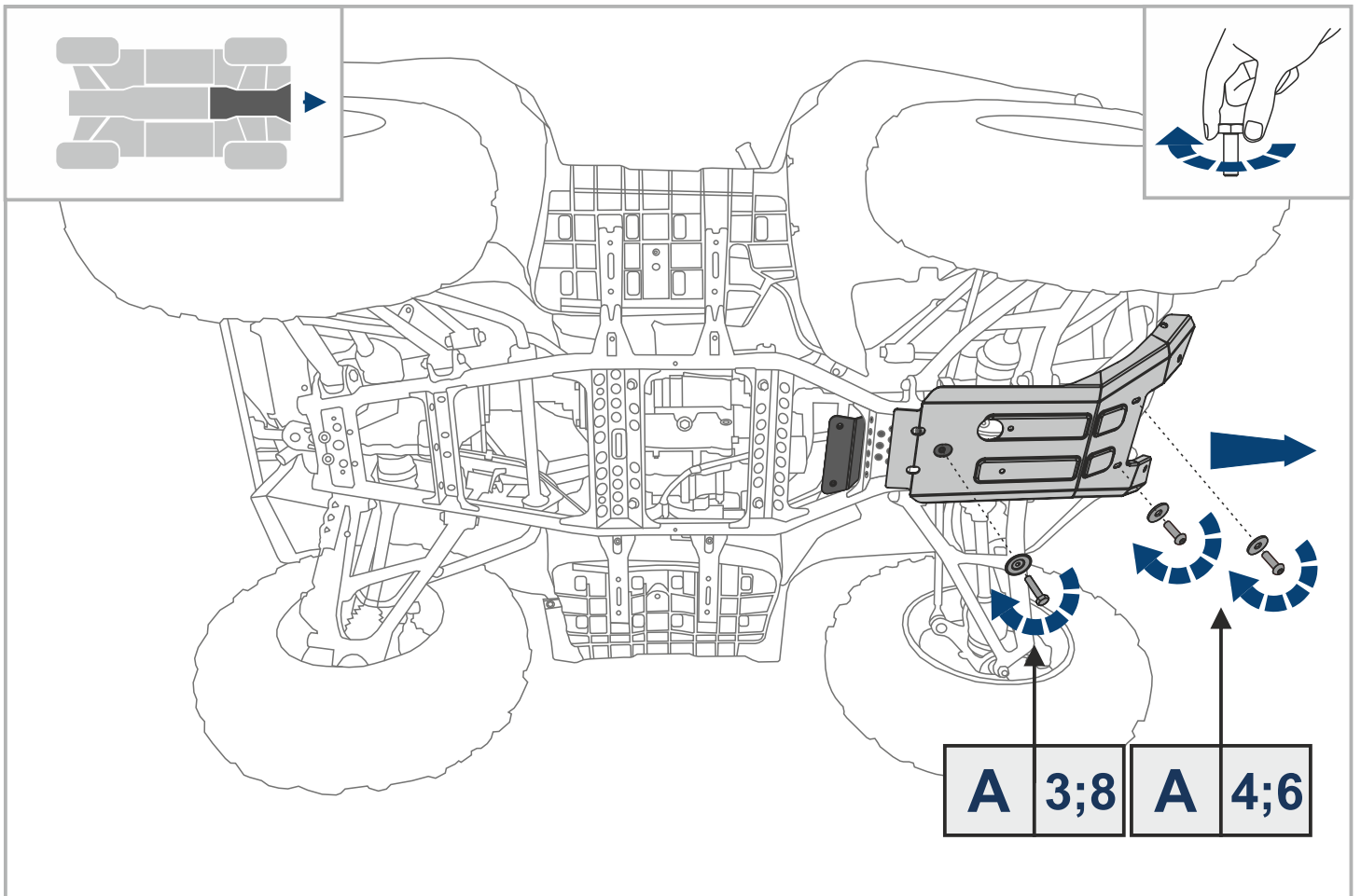

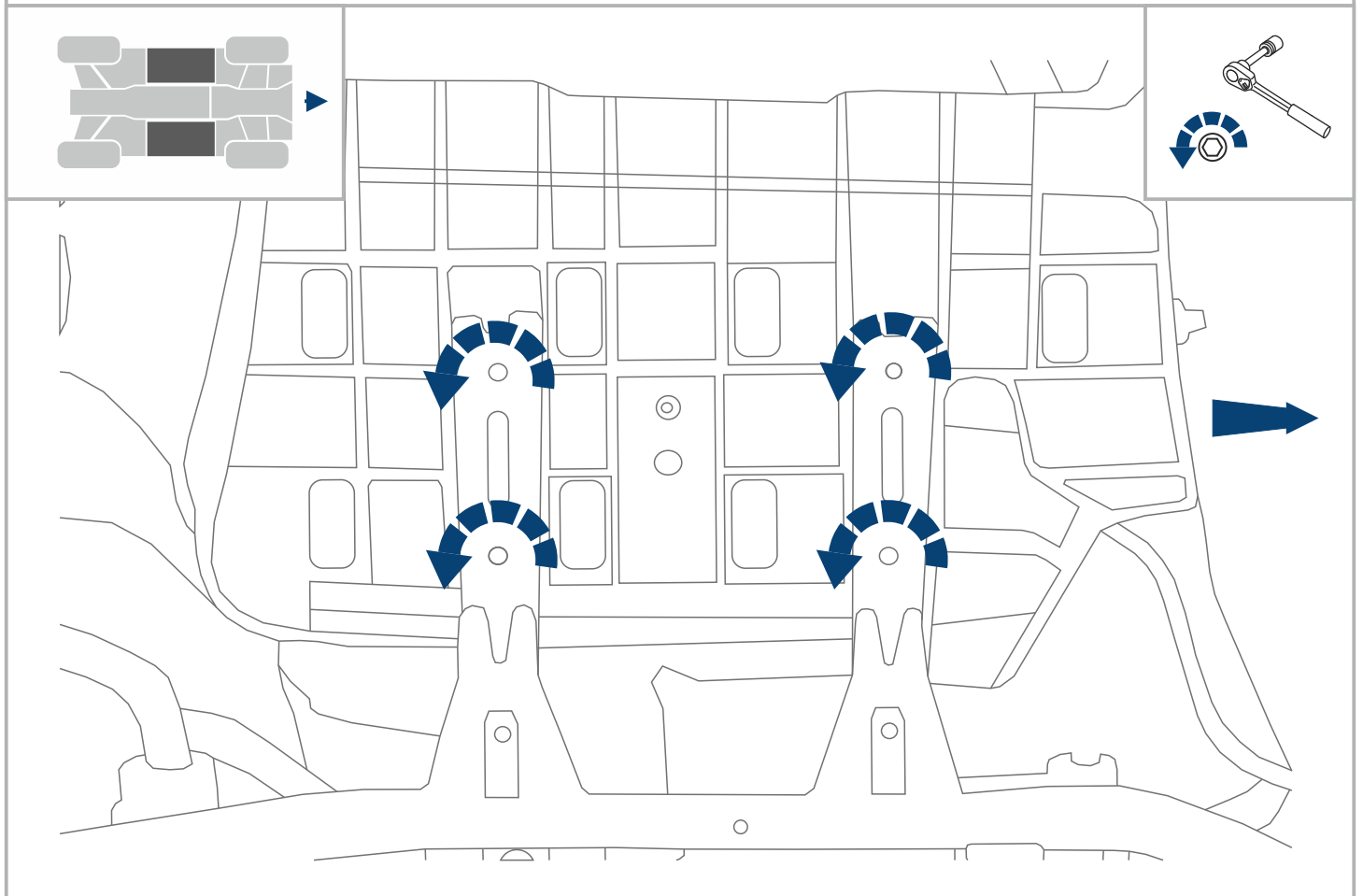
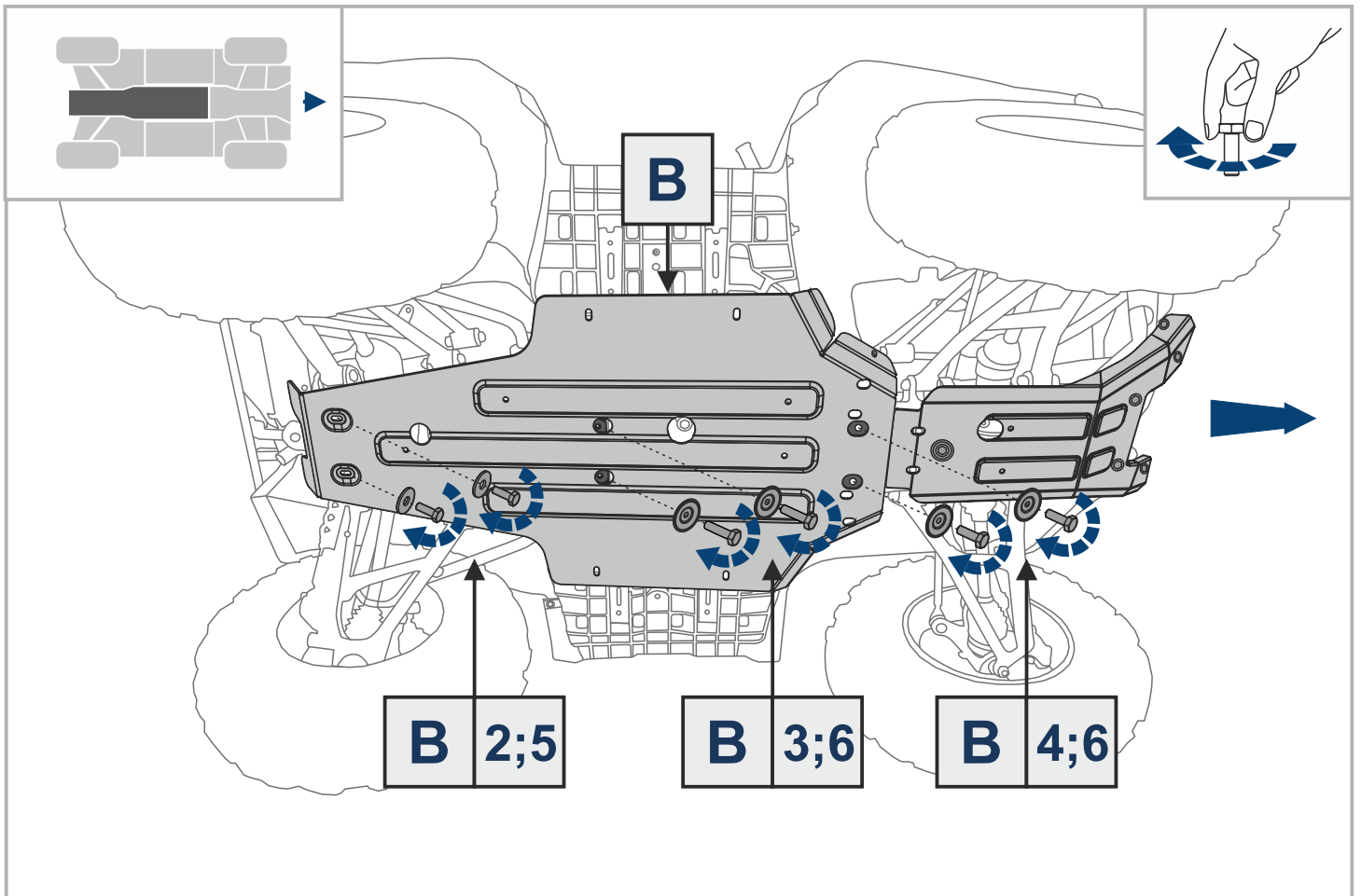

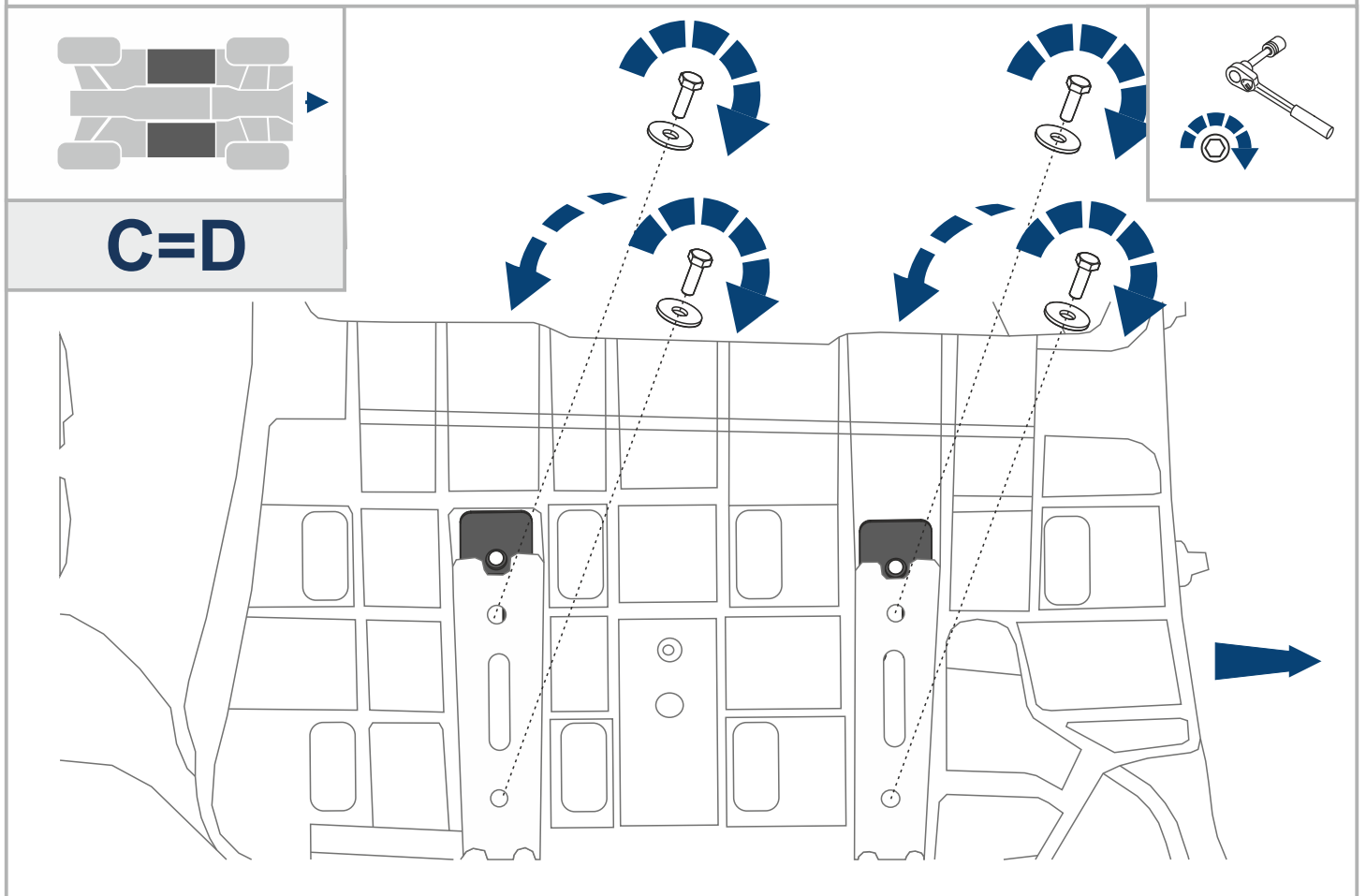
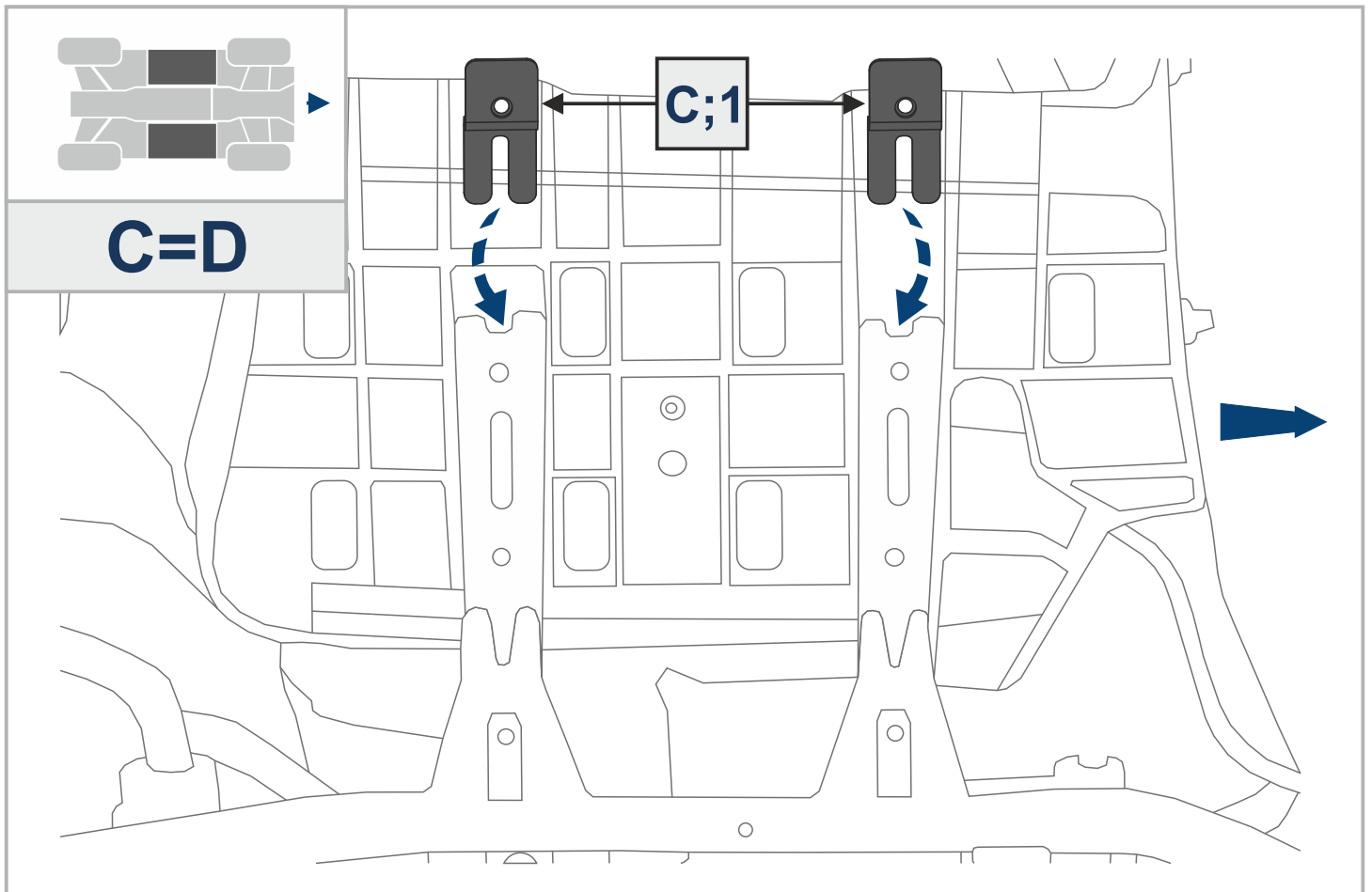



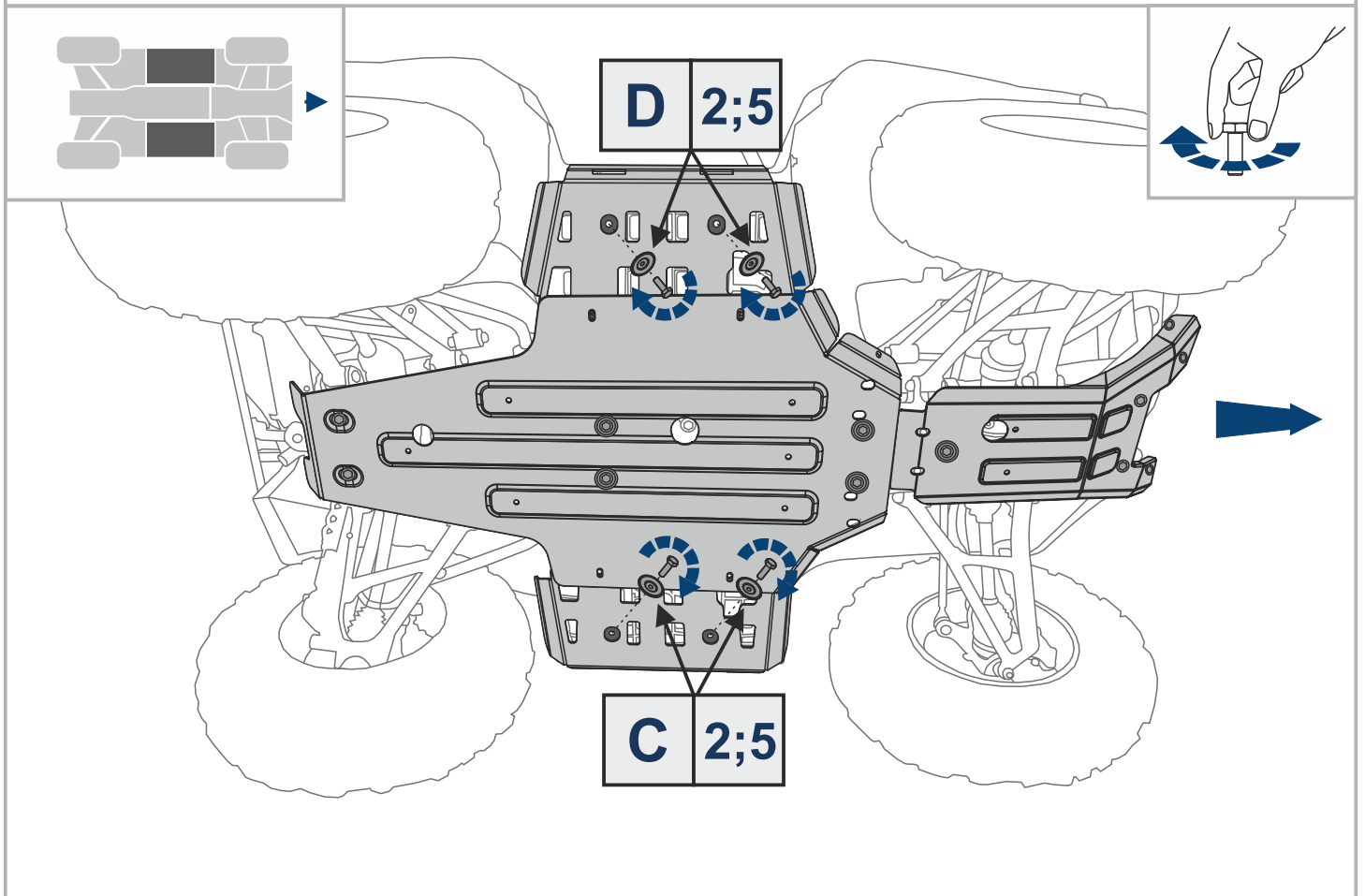
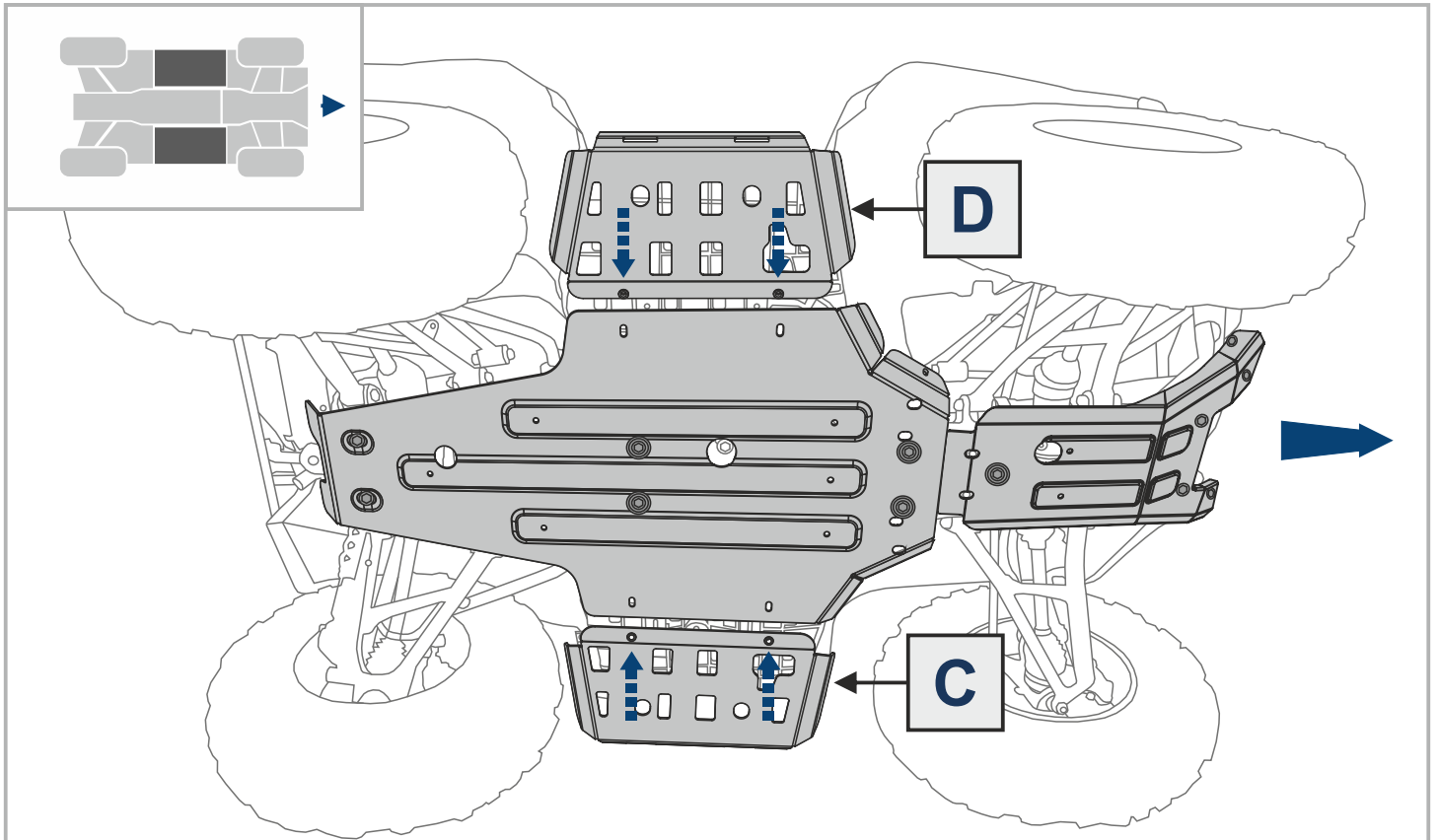

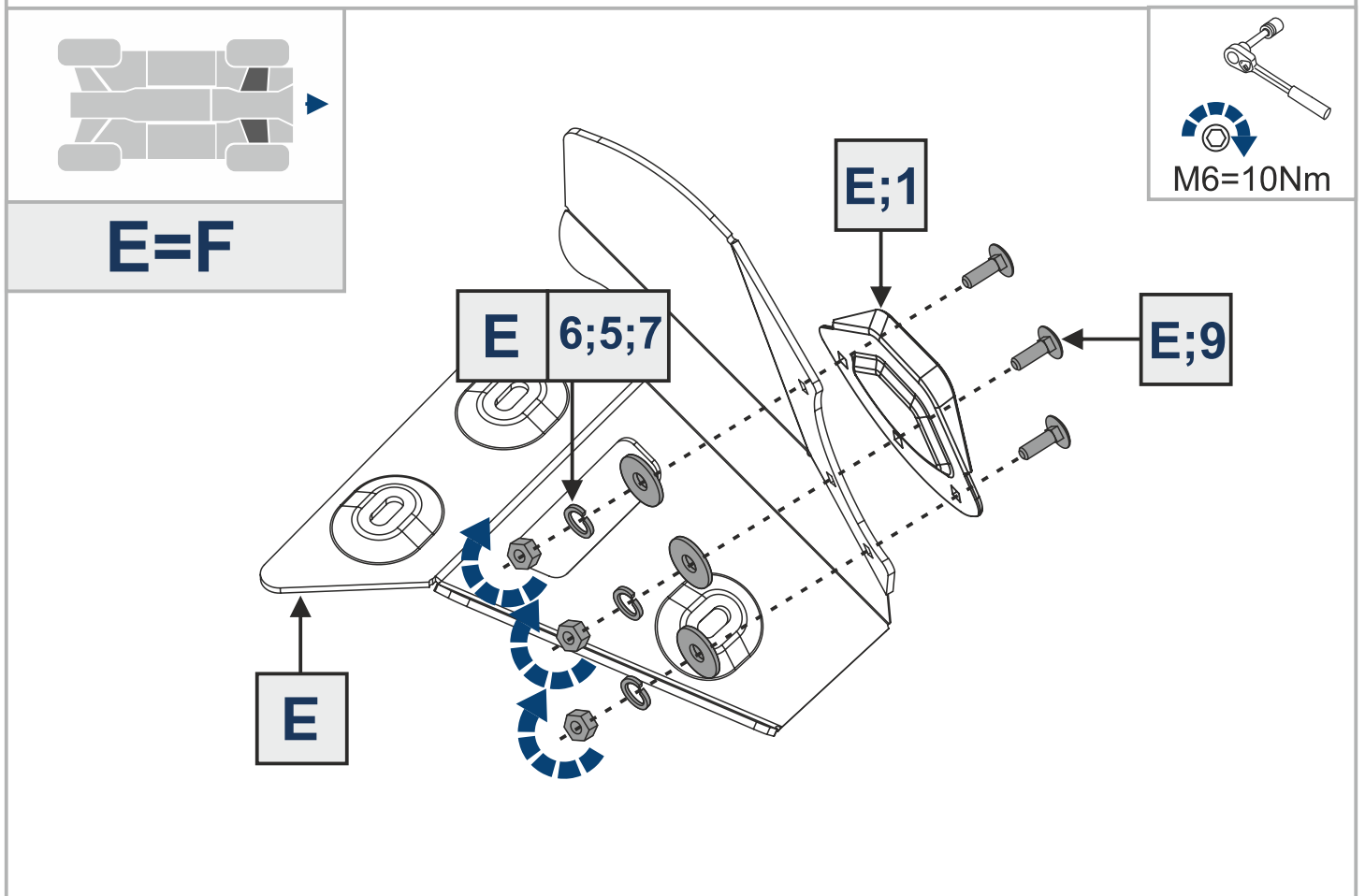
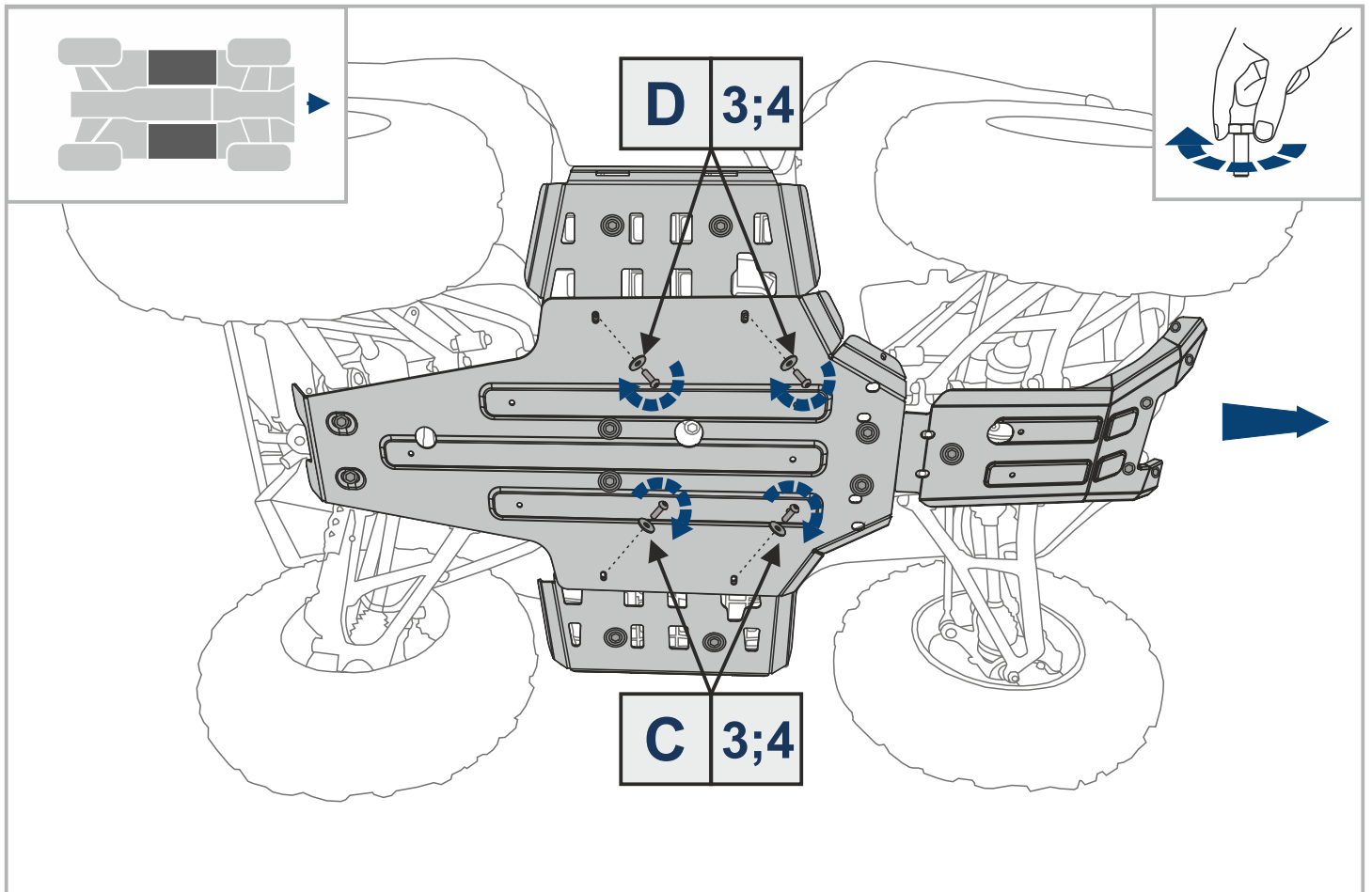

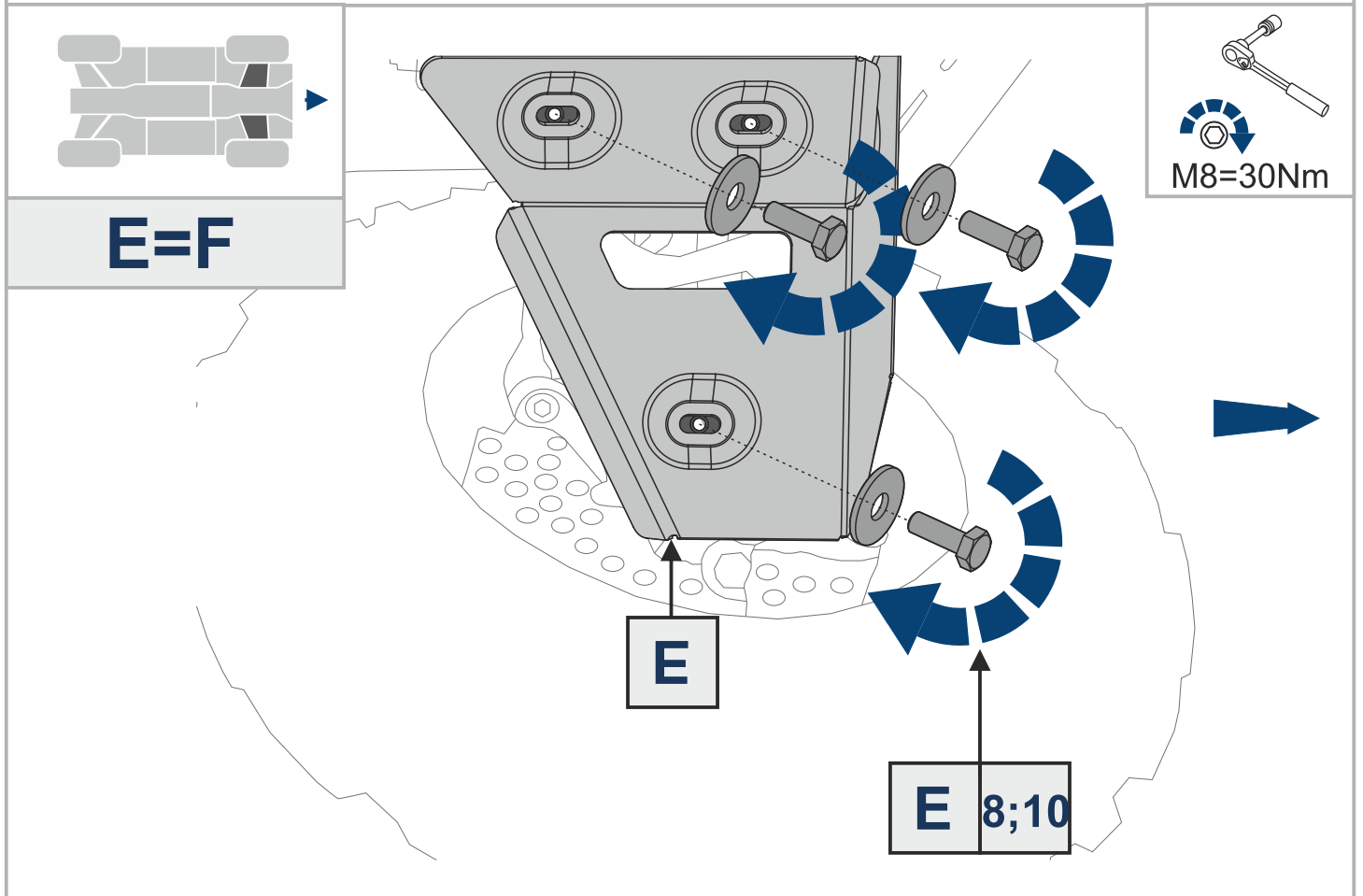
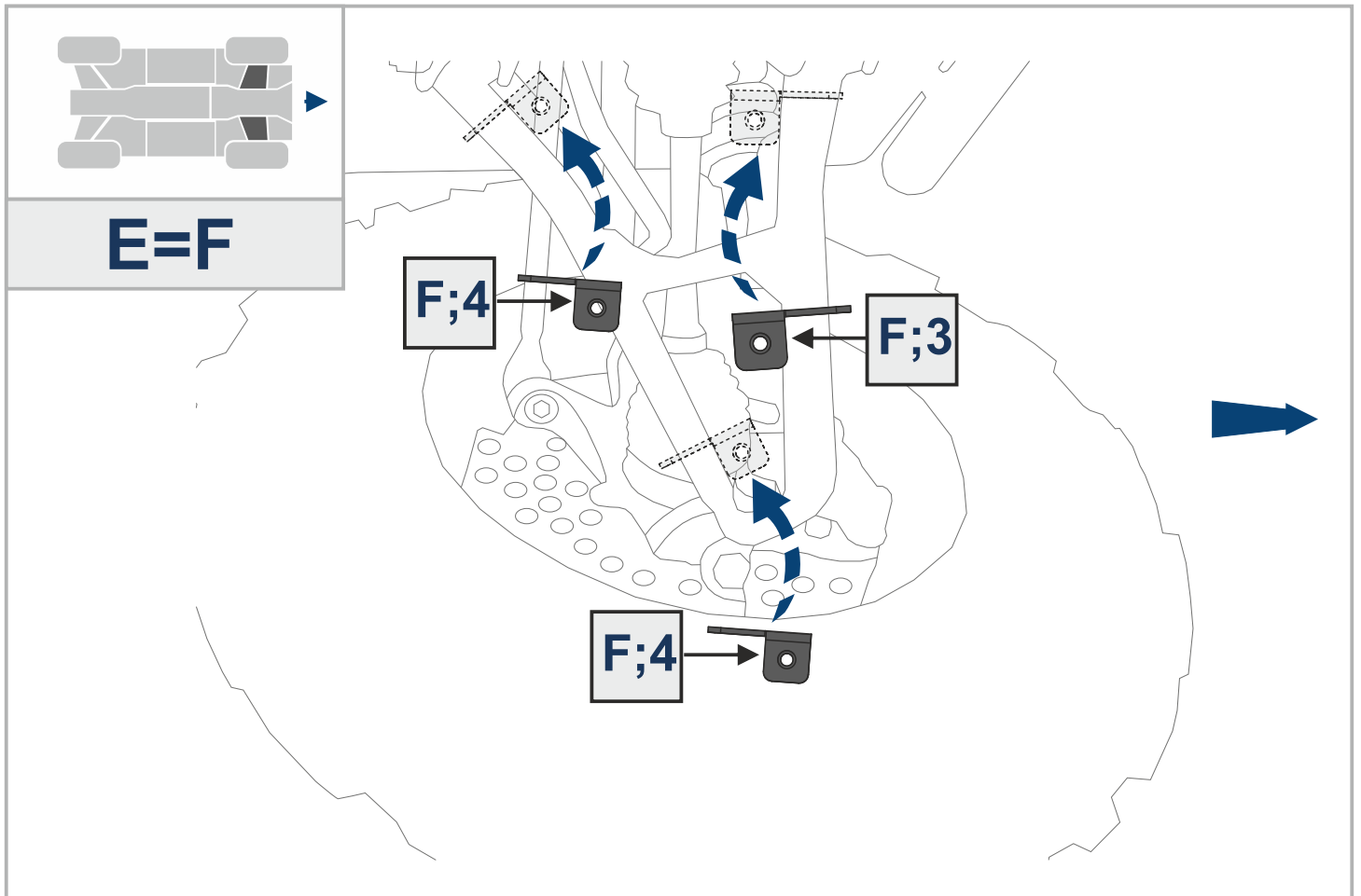

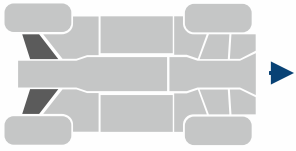

**H=G**

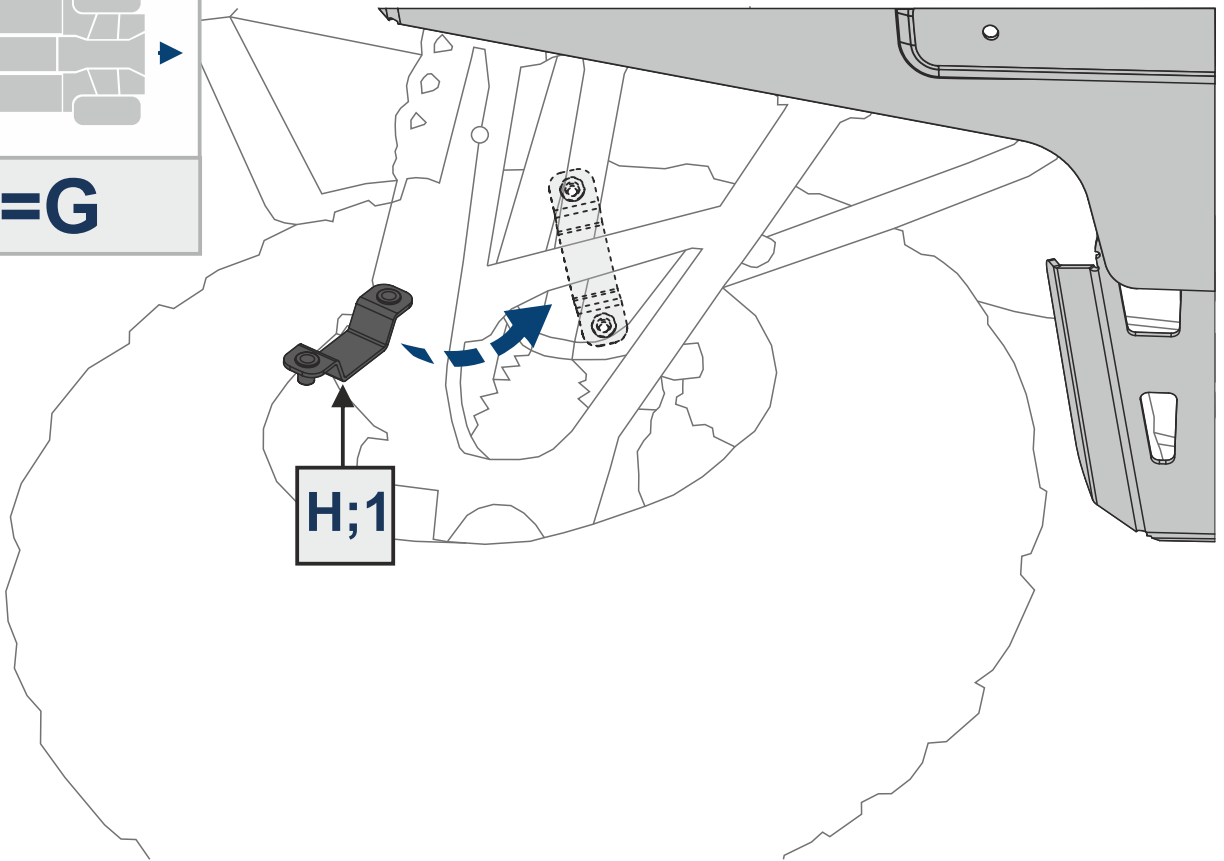

**H;1**

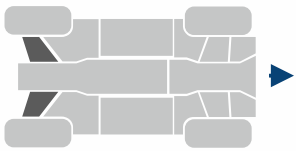

**H=G**

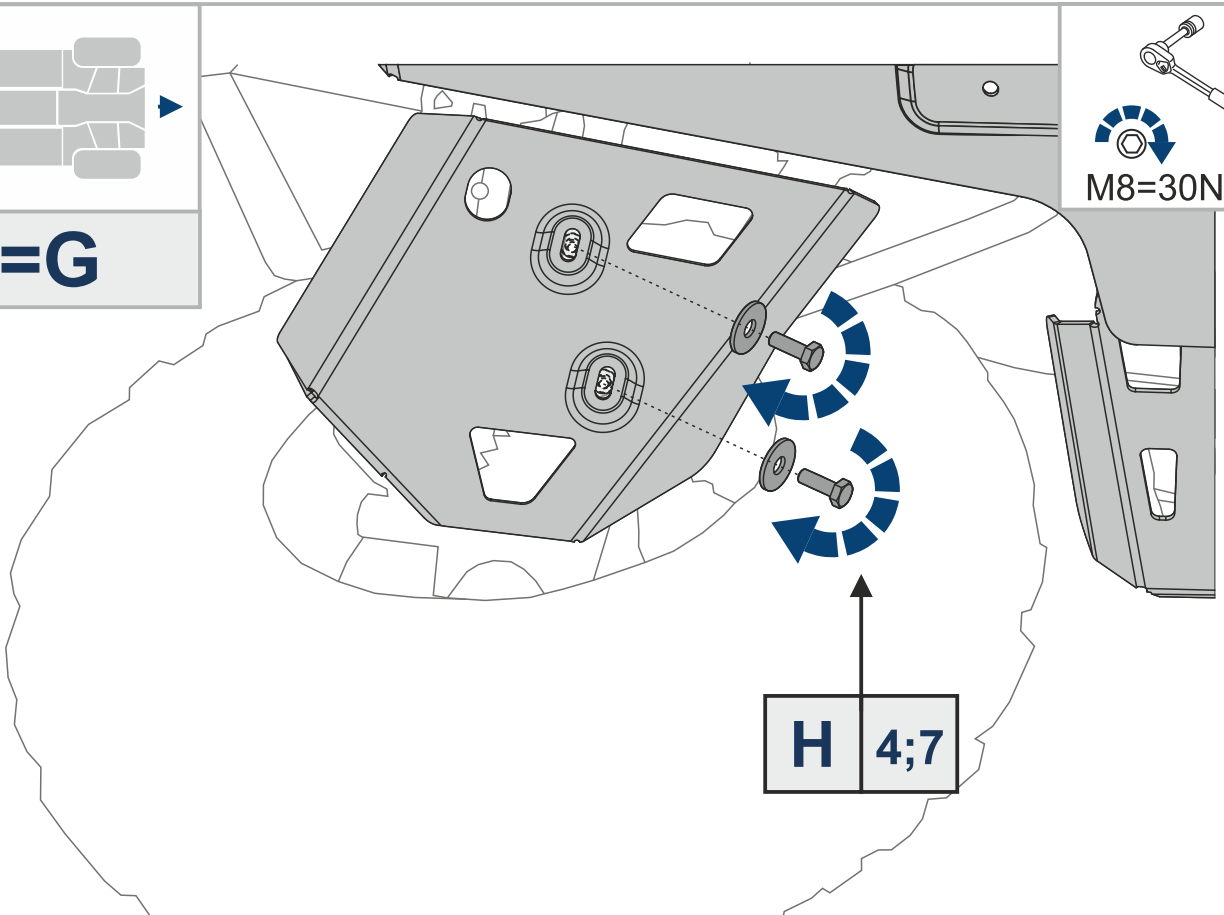

  
  
**M8=30Nm**

**H 4;7**

